

REVISION HISTORY			
REV.	DESCRIPTION	DATE	APPROVED

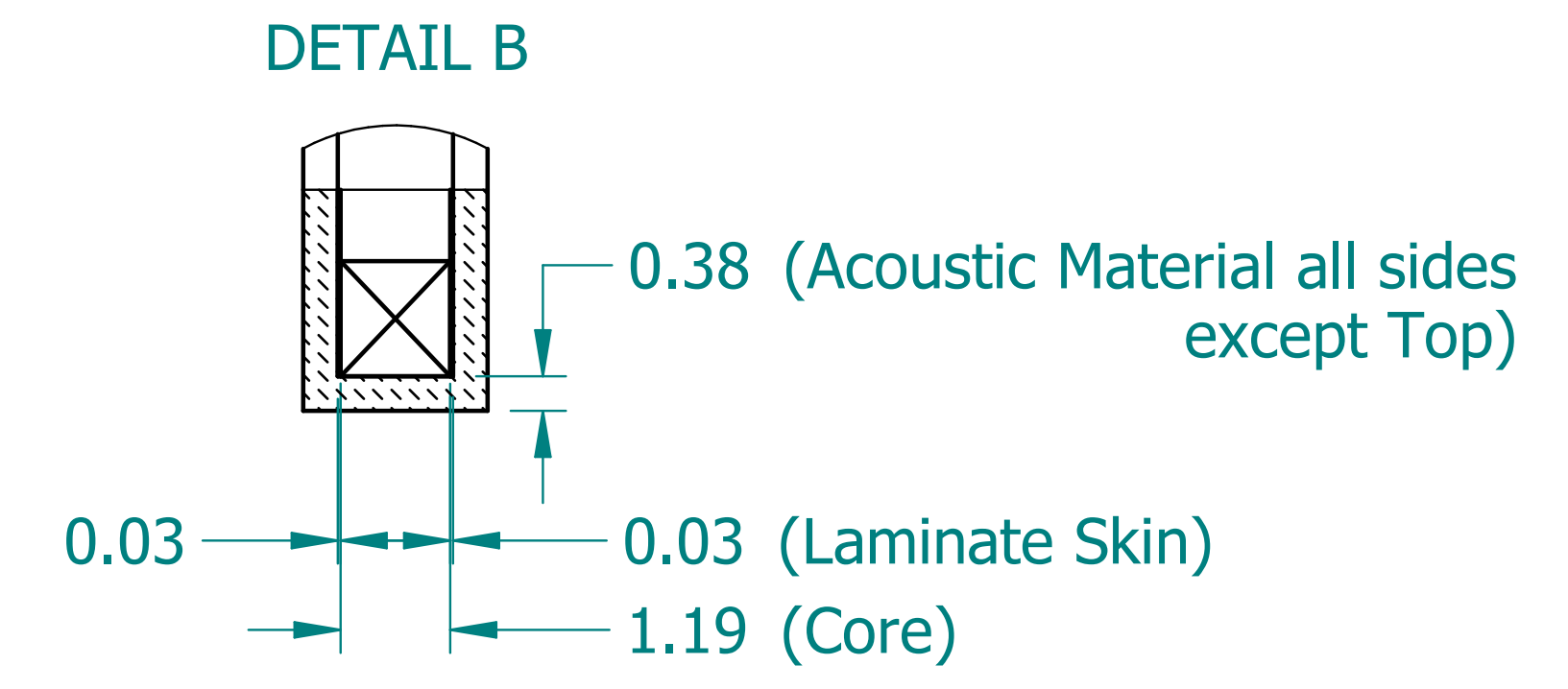

	NAME	DATE
DRAWN	SAI	03/11/20
ENG APPR	ERIC	03/11/20

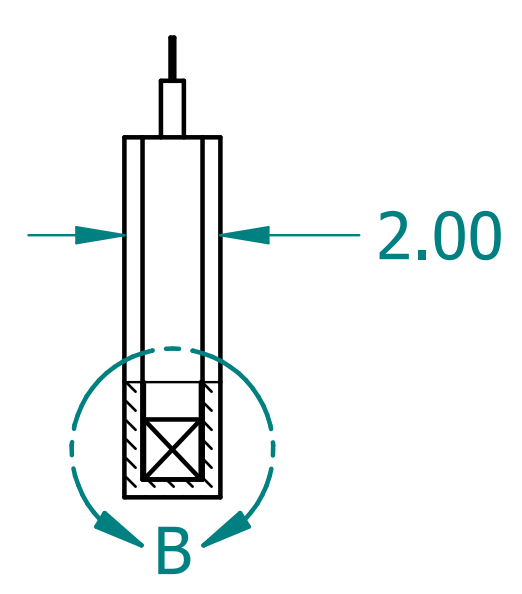
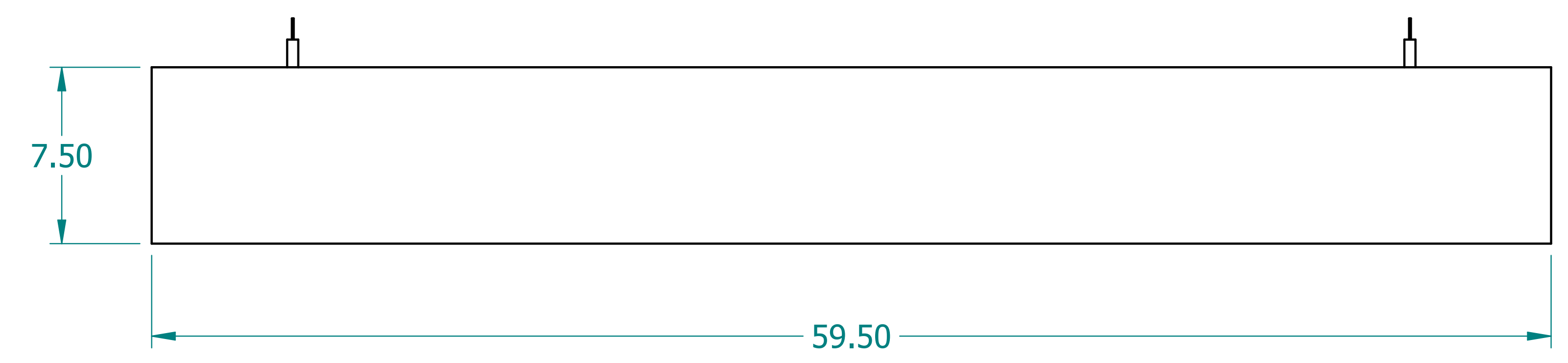
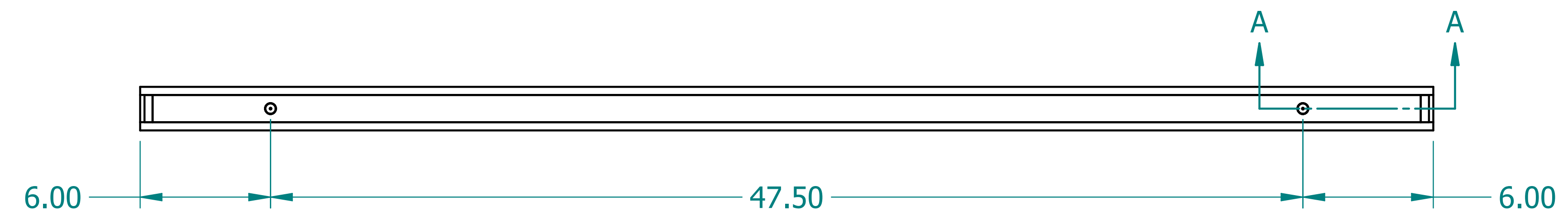
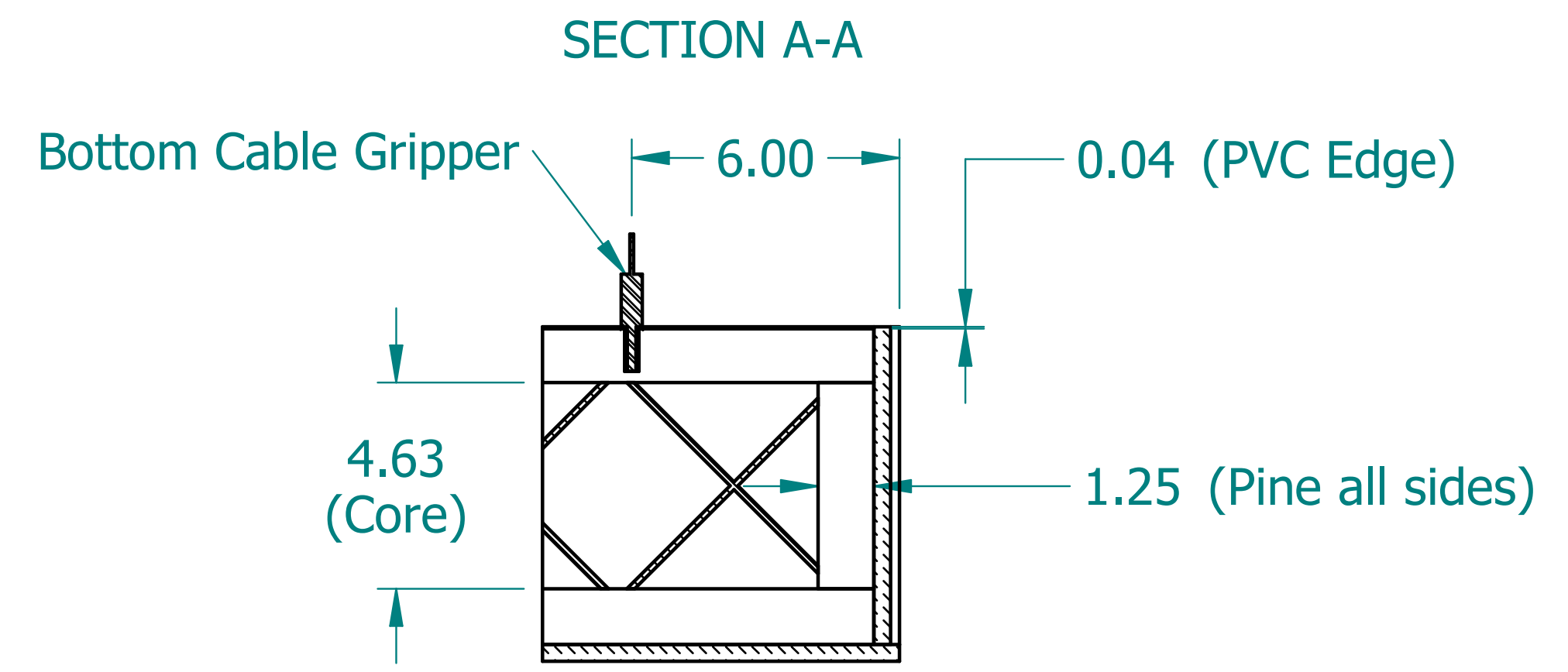
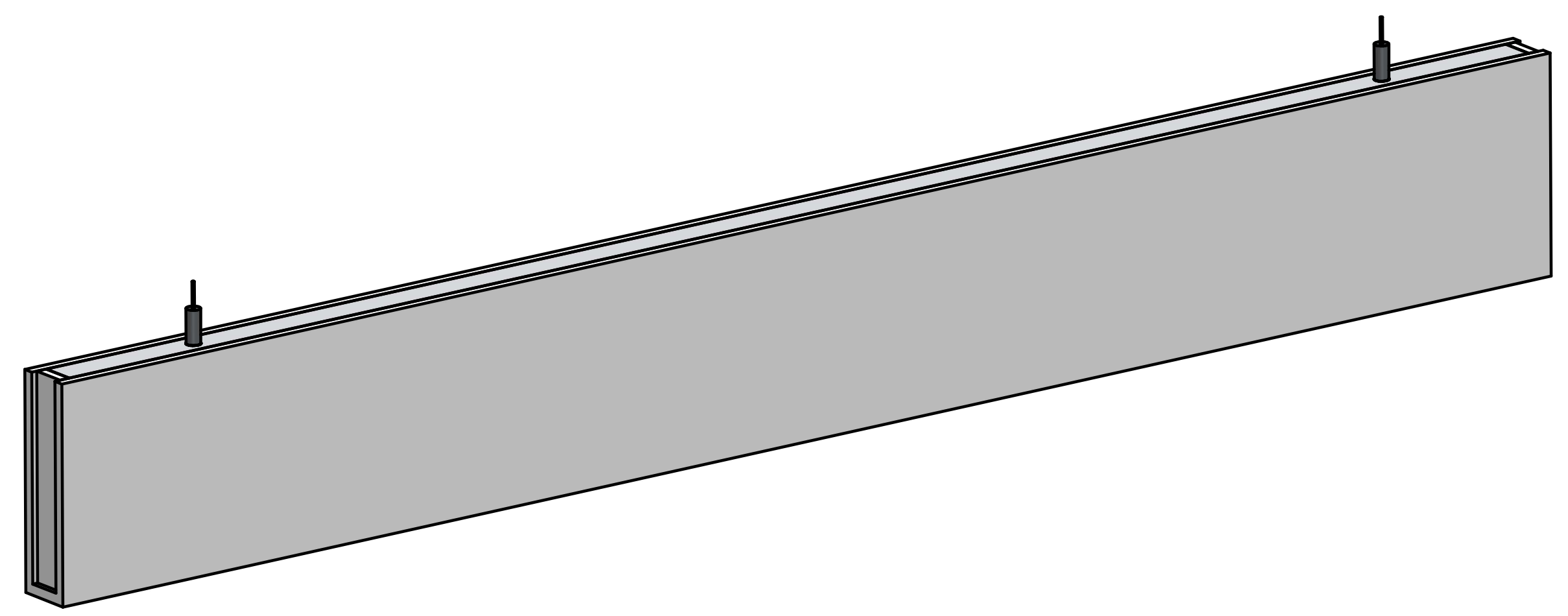

UNLESS OTHERWISE SPECIFIED DIMENSIONS ARE IN 'INCHES'  
 ANGLES  $\pm 0.8^\circ$  ; 2 PL  $\pm 0.040$  ;  
 3 PL  $\pm 0.020$

TITLE <b>Acoustic Blade</b>	
SUBTITLE 60"x8"x2"	
PART NO: ABlade-030-XX	REV. 1.0
SIZE: 34"x22"	SCALE: 0.25
SHEET 1 OF 1	
FILE NAME: Acoustic Blade (60.8.2).dft	