

REVISION HISTORY			
REV.	DESCRIPTION	DATE	APPROVED

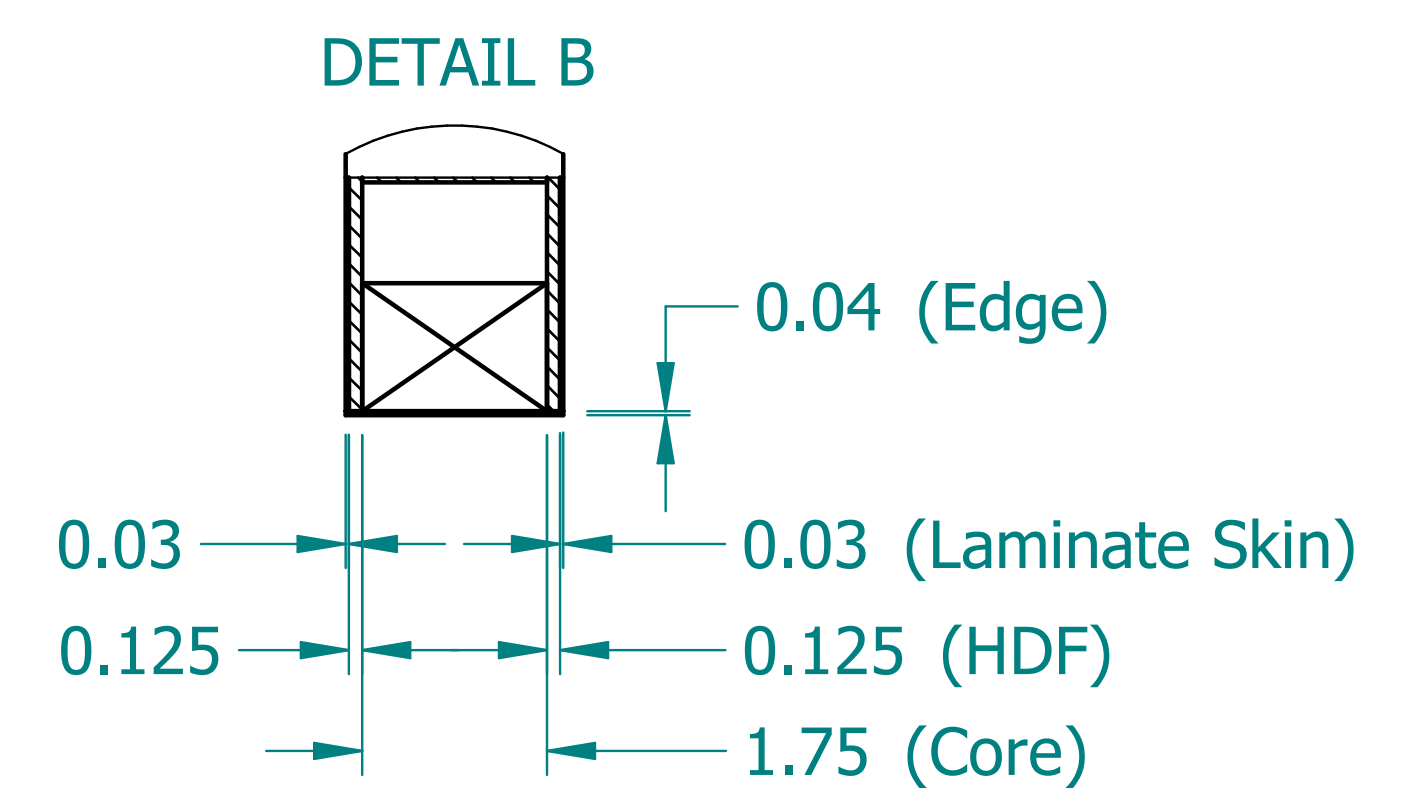
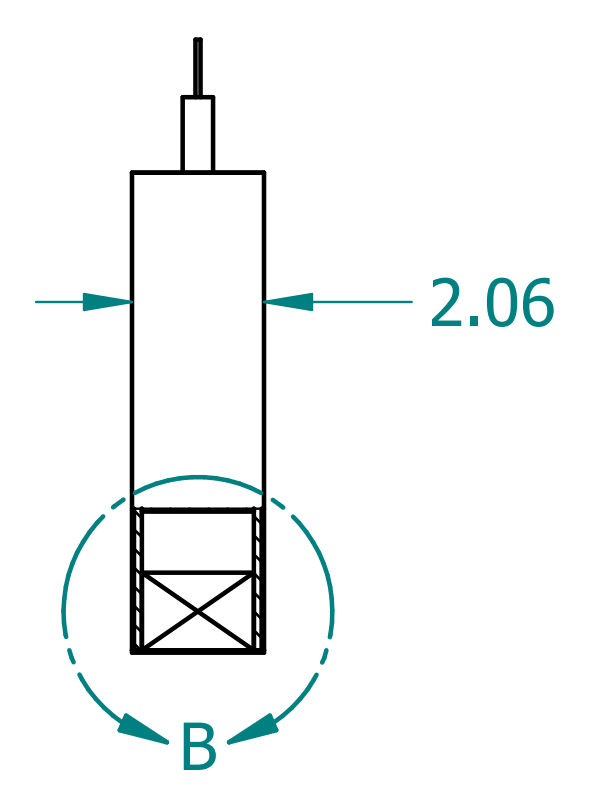
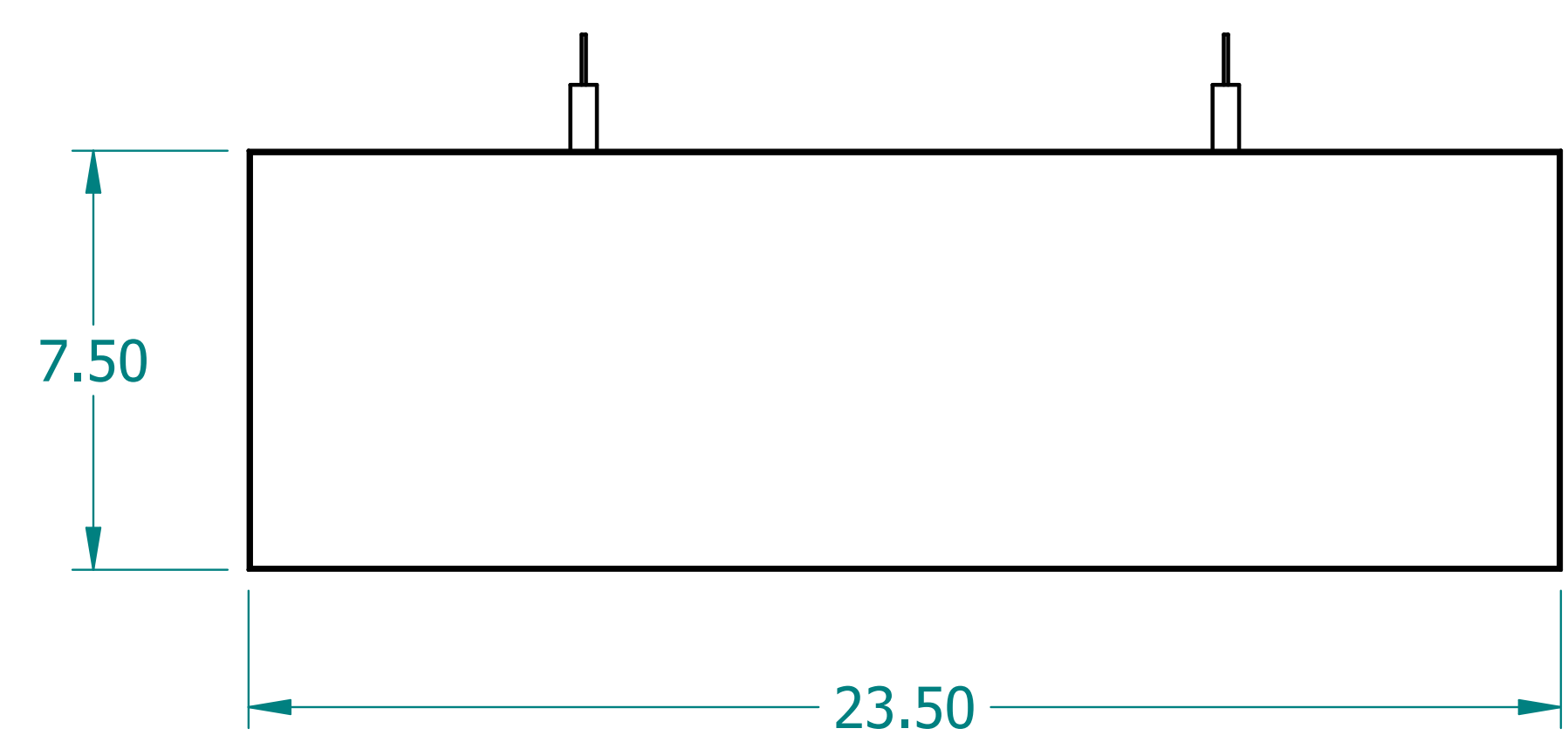
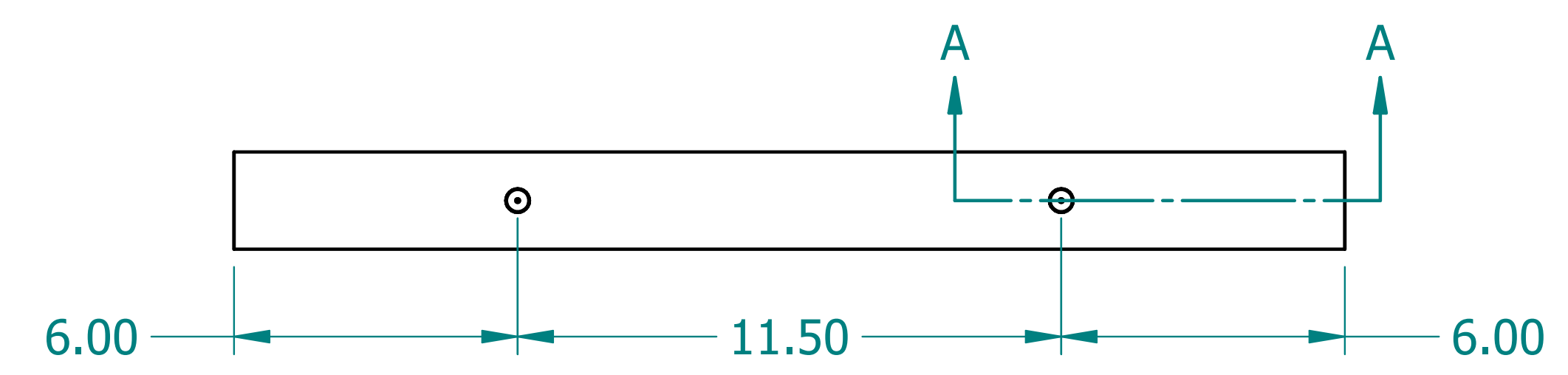
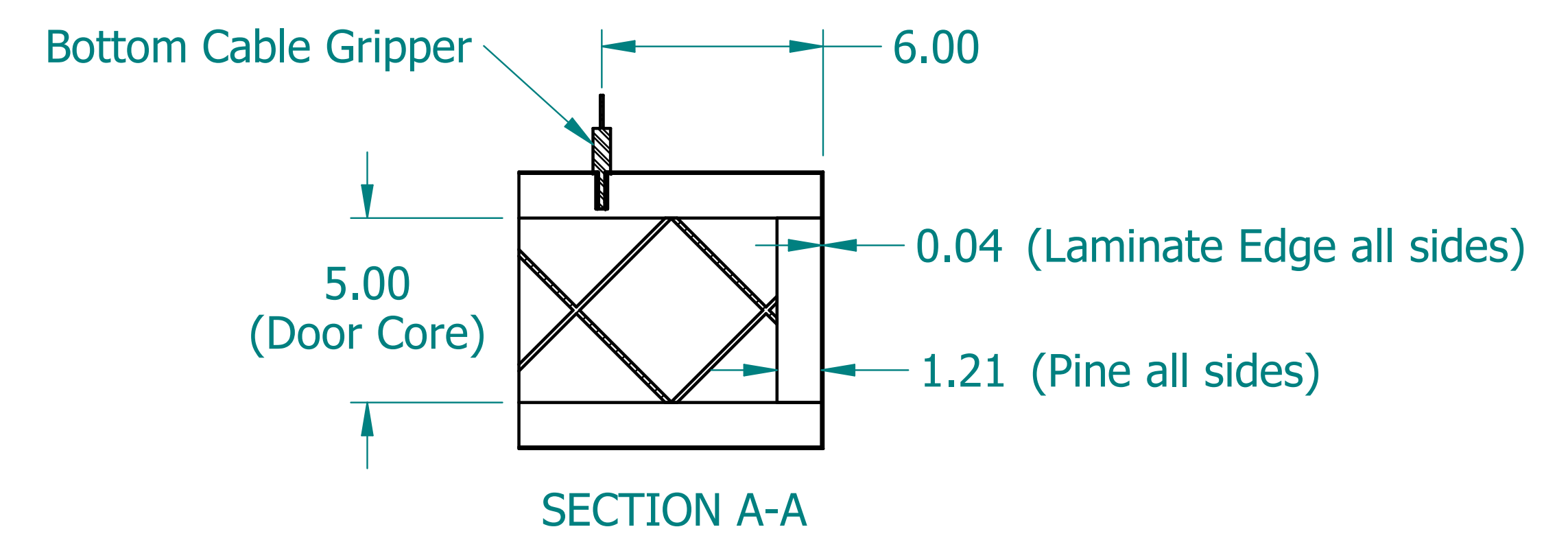
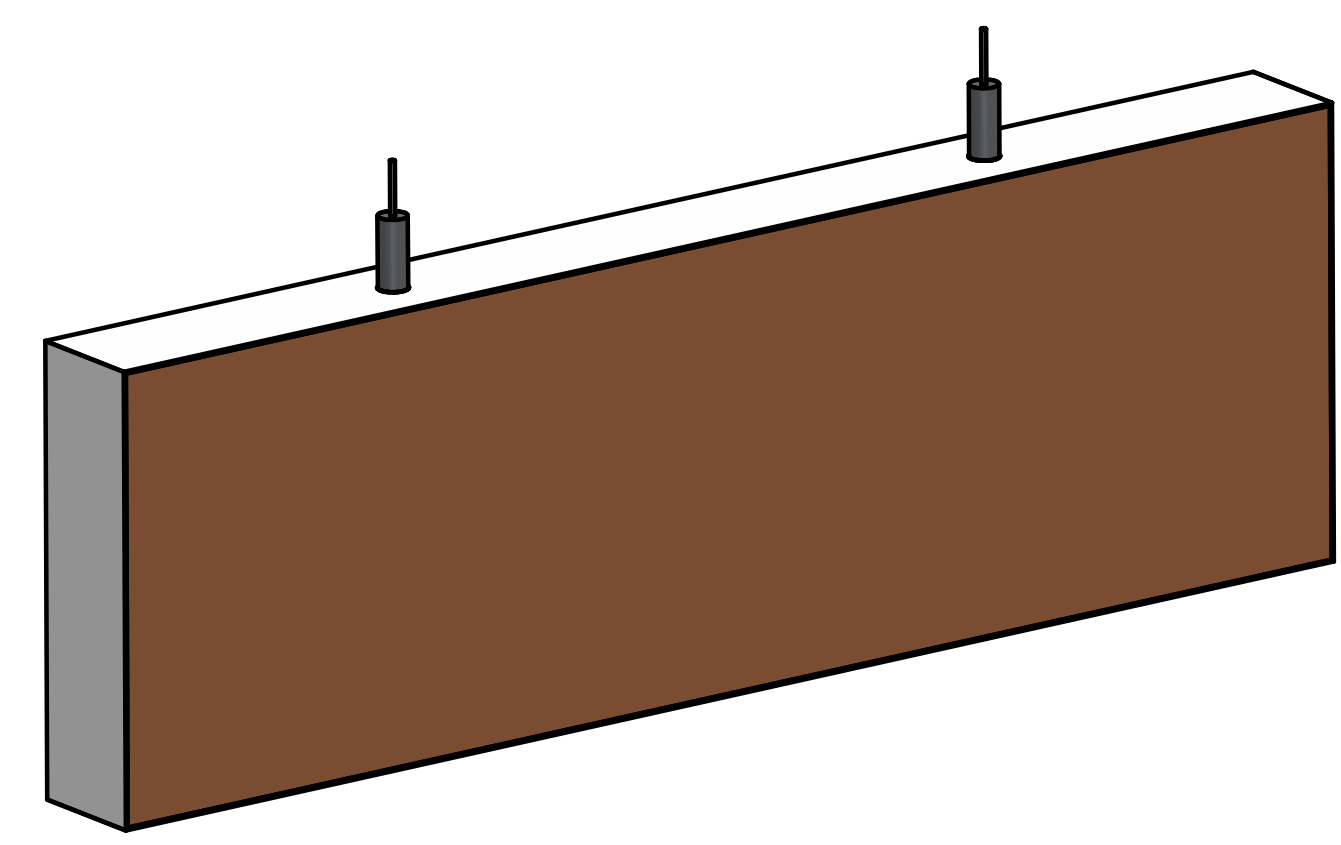

NAME	DATE	
DRAWN: SAI	03/11/20	
ENG APPR: ERIC	03/11/20	
<p>UNLESS OTHERWISE SPECIFIED DIMENSIONS ARE IN 'INCHES'</p> <p>ANGLES ±0.8° ; 2 PL ±0.040 ; 3 PL ±0.020</p>		<p>TITLE: Laminate Beam</p> <p>SUBTITLE: 24"x8"x2"</p> <p>PART NO: Beam-006-XX REV: 1.0</p> <p>SIZE: 34"x22" SCALE: 0.33 SHEET 1 OF 1</p> <p>FILE NAME: Laminated Beam (24.8.2).dft</p>