

REVISION HISTORY			
REV.	DESCRIPTION	DATE	APPROVED

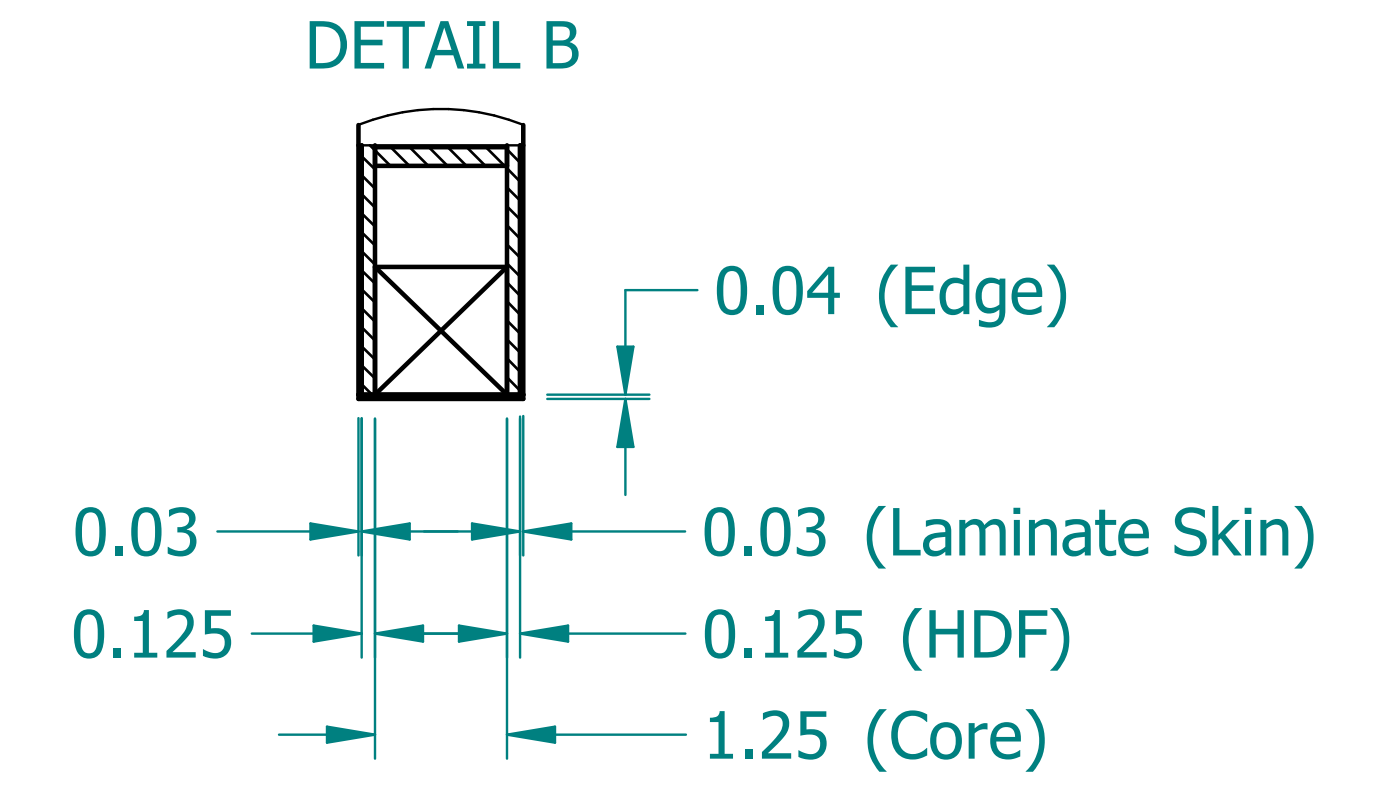
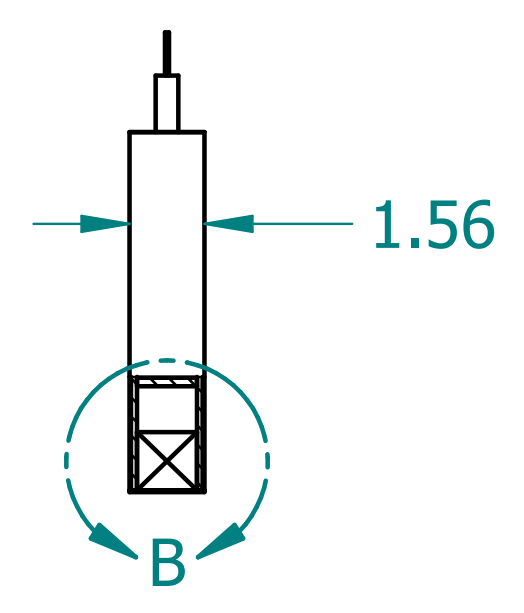
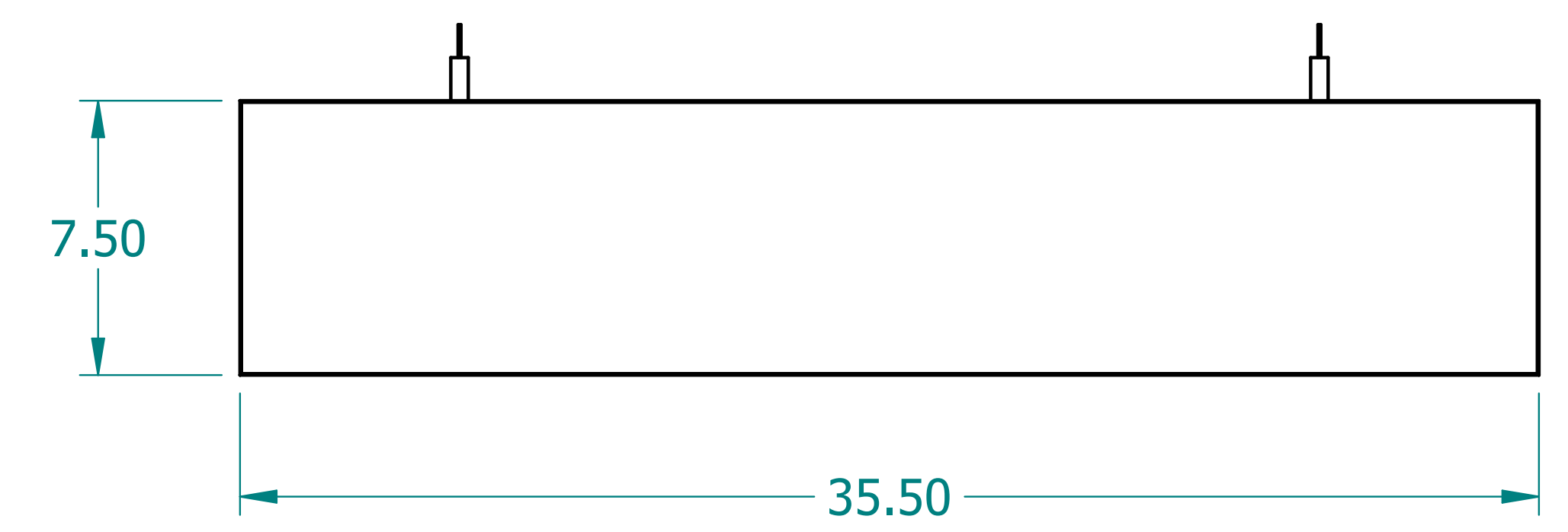
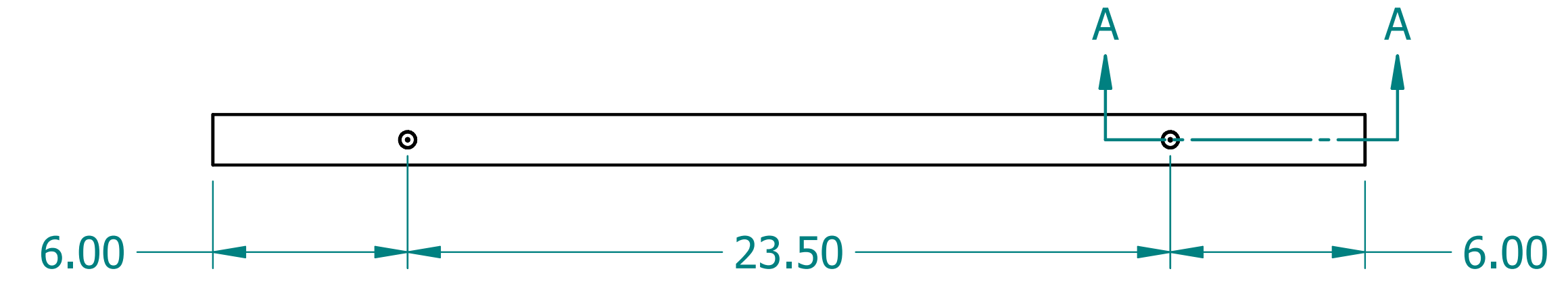
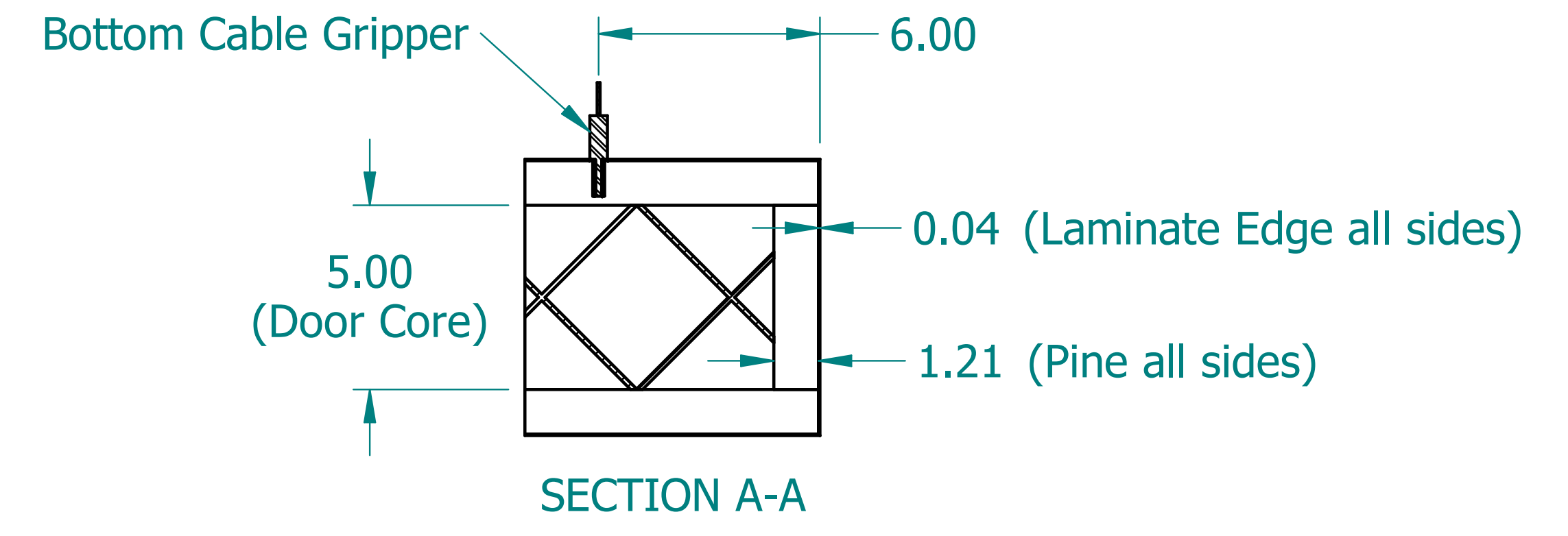
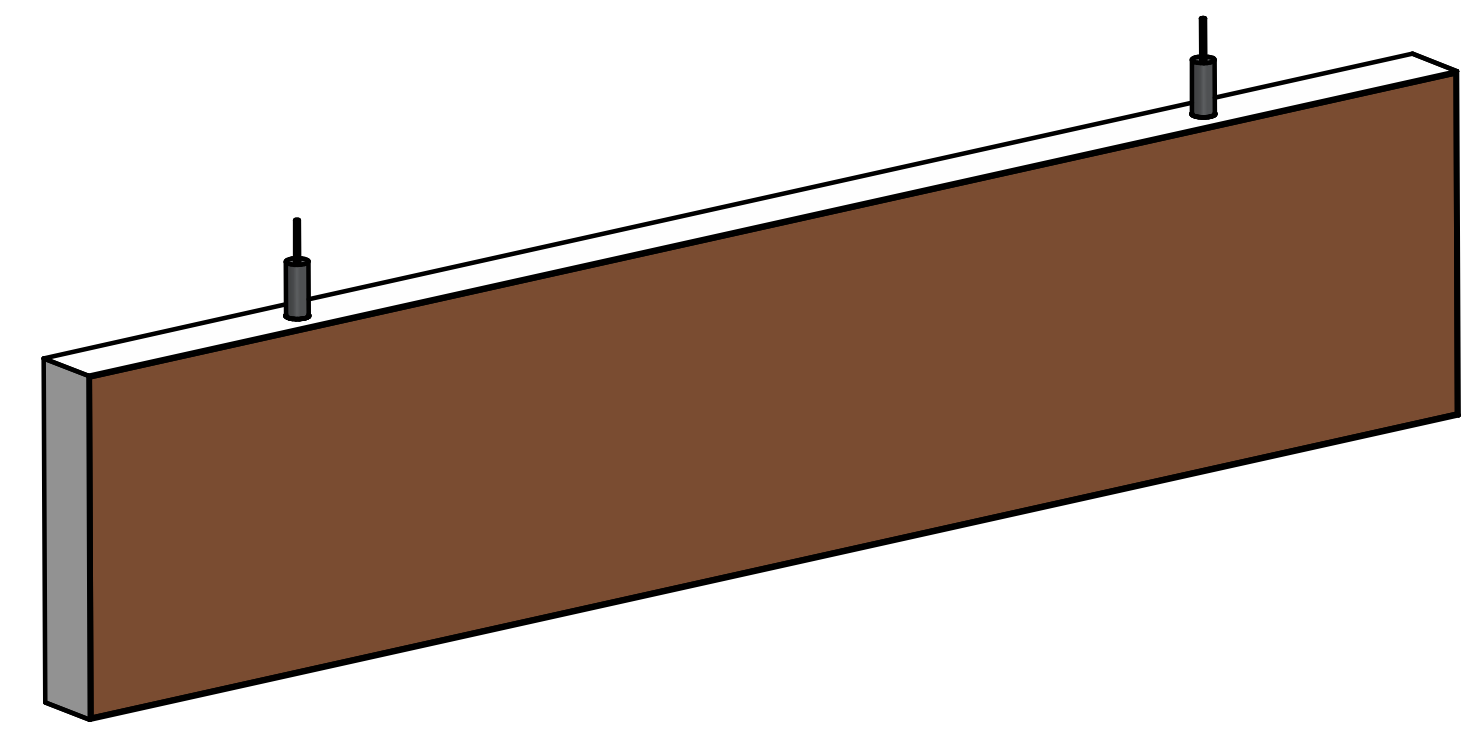

NAME	DATE	
DRAWN: SAI	03/11/20	
ENG APPR: ERIC	03/11/20	
<p>UNLESS OTHERWISE SPECIFIED DIMENSIONS ARE IN 'INCHES'</p> <p>ANGLES $\pm 0.8^\circ$; 2 PL ± 0.040 ; 3 PL ± 0.020</p>		<p>TITLE: Laminate Beam</p> <p>SUBTITLE: 36"x8"x1.5"</p> <p>PART NO: Beam-014-XX REV. 1.0</p> <p>SIZE: 34"x22" SCALE: 0.25 SHEET 1 OF 1</p> <p>FILE NAME: Laminated Beam (36.8.1.5).dft</p>