

REVISION HISTORY			
REV.	DESCRIPTION	DATE	APPROVED

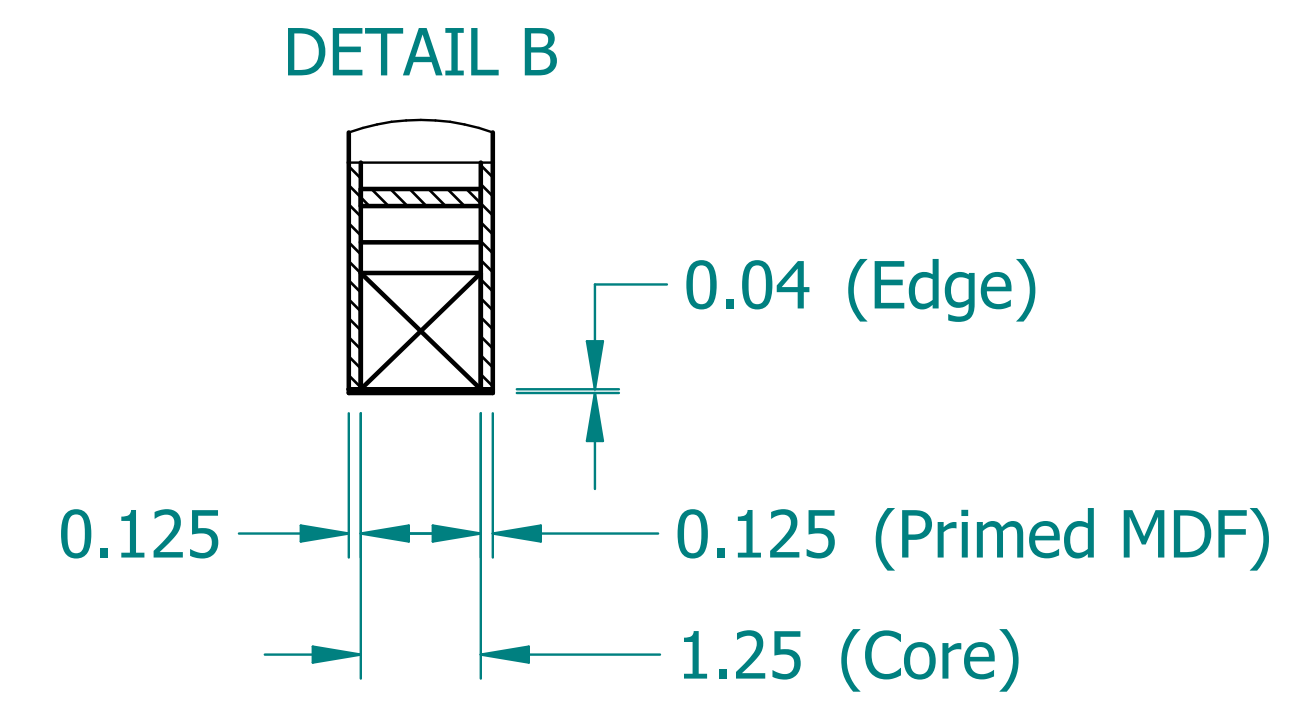

	NAME	DATE
DRAWN	SAI	03/11/20
ENG APPR	ERIC	03/11/20

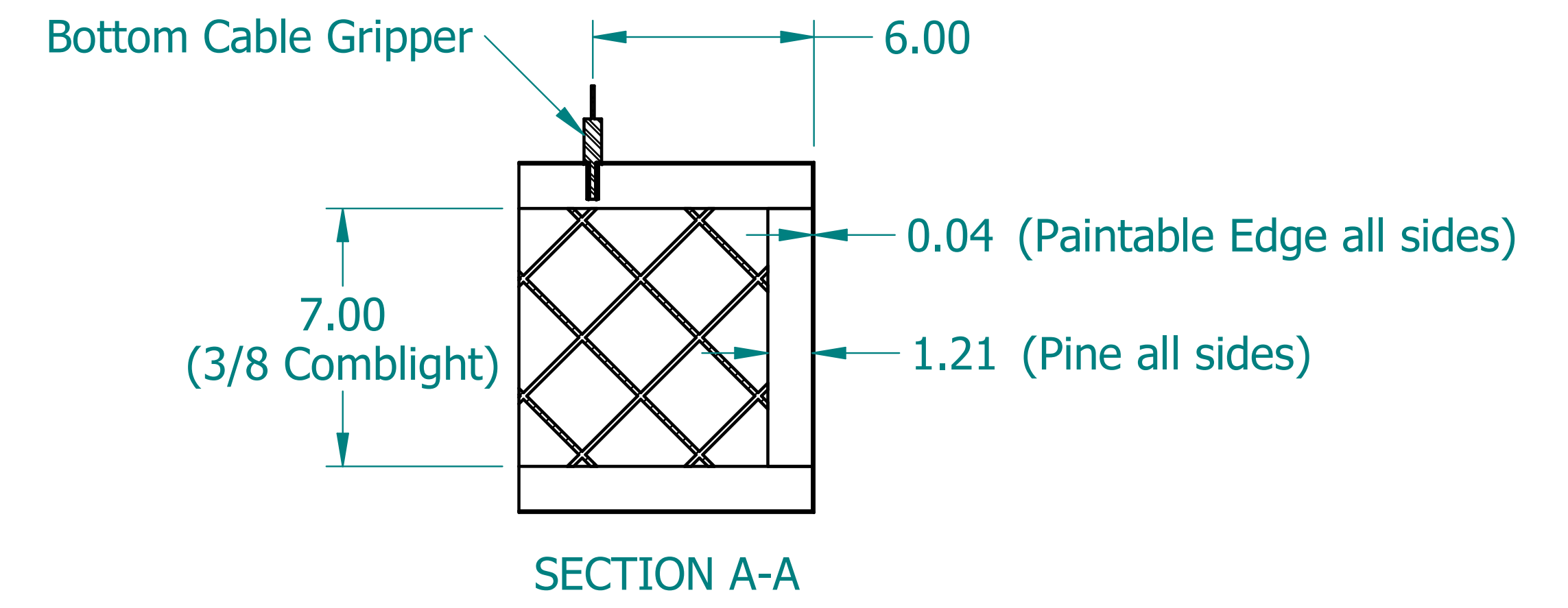
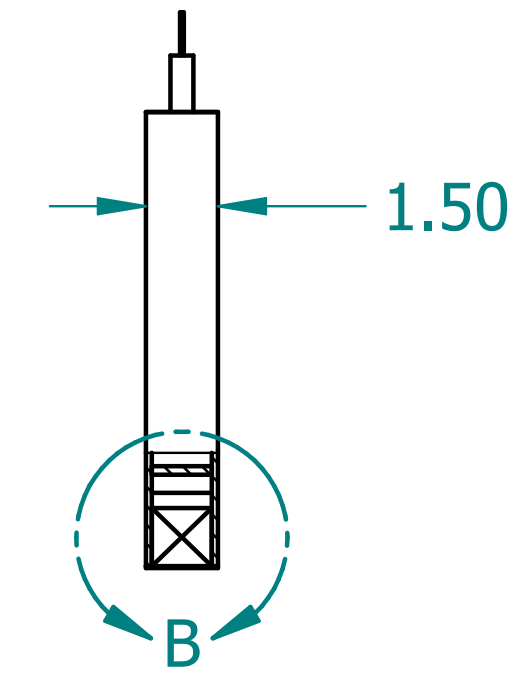
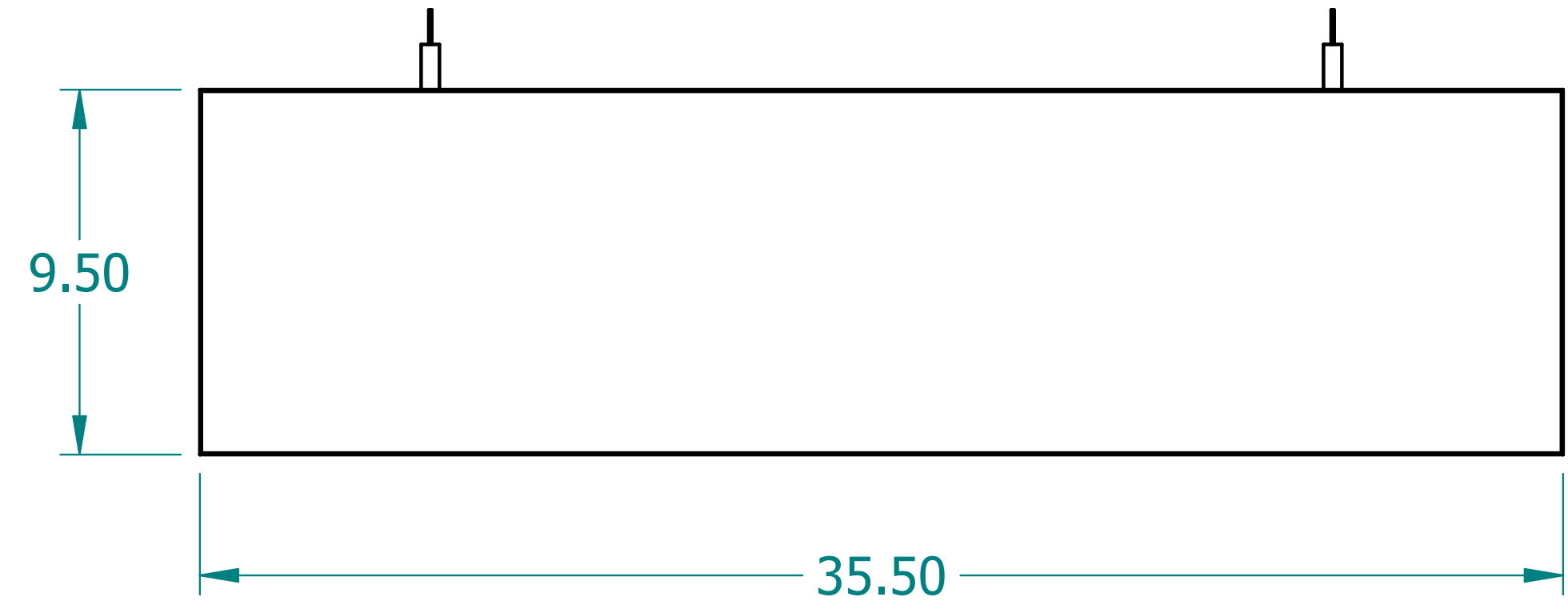
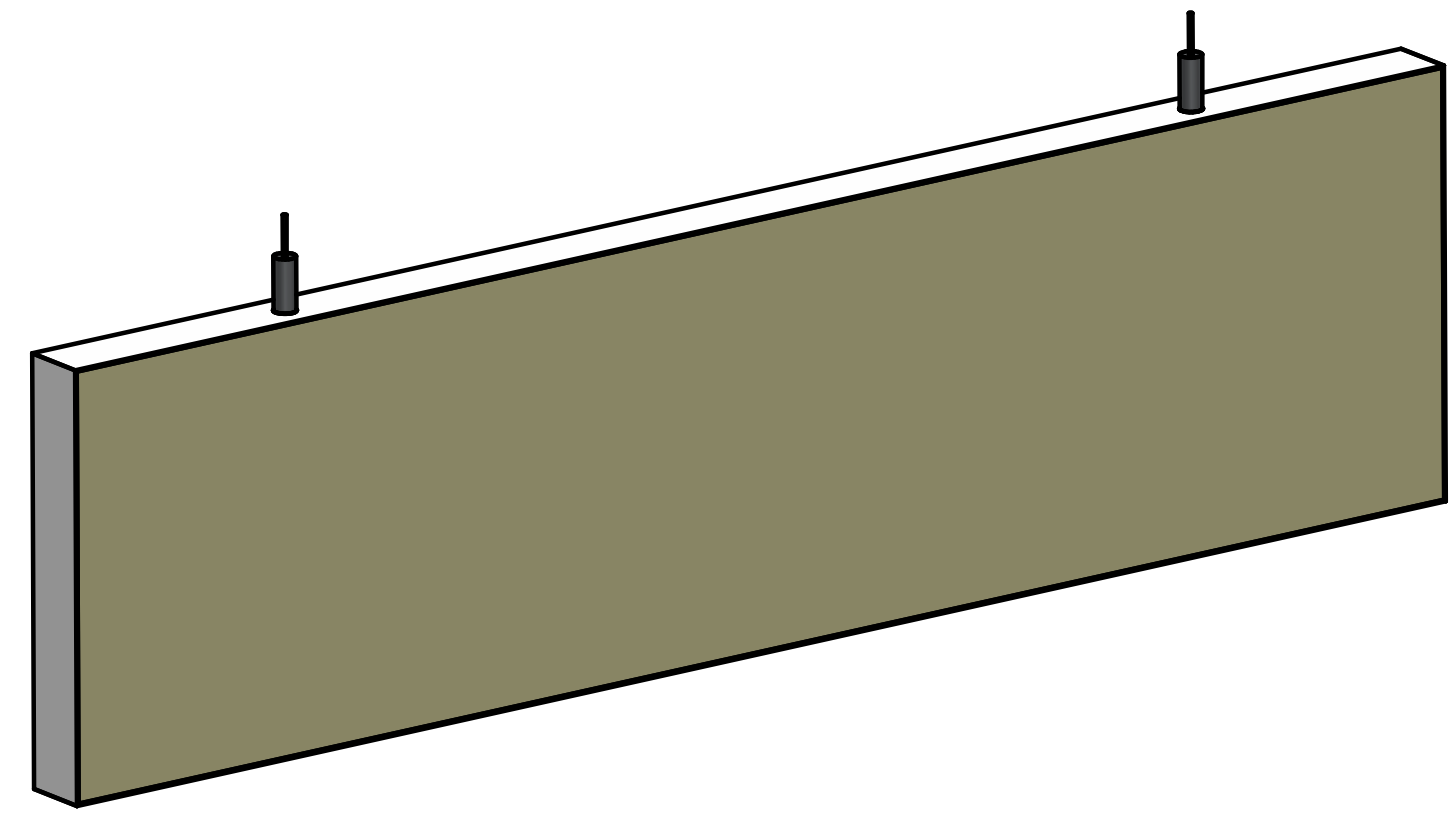
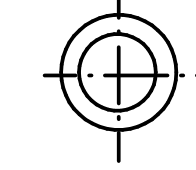

 UNLESS OTHERWISE SPECIFIED DIMENSIONS ARE IN 'INCHES'
 ANGLES $\pm 0.8^\circ$; 2 PL ± 0.040 ; 3 PL ± 0.020

TITLE		Paintable Beam	
SUBTITLE		36"x10"x1.5"	
PART NO:	Beam-015-PG	REV.	1.0
SIZE: 34"x22"	SCALE: 0.25	SHEET 1 OF 1	
FILE NAME: Paintable Beam (36.10.1.5).dft			