

REVISION HISTORY			
REV.	DESCRIPTION	DATE	APPROVED

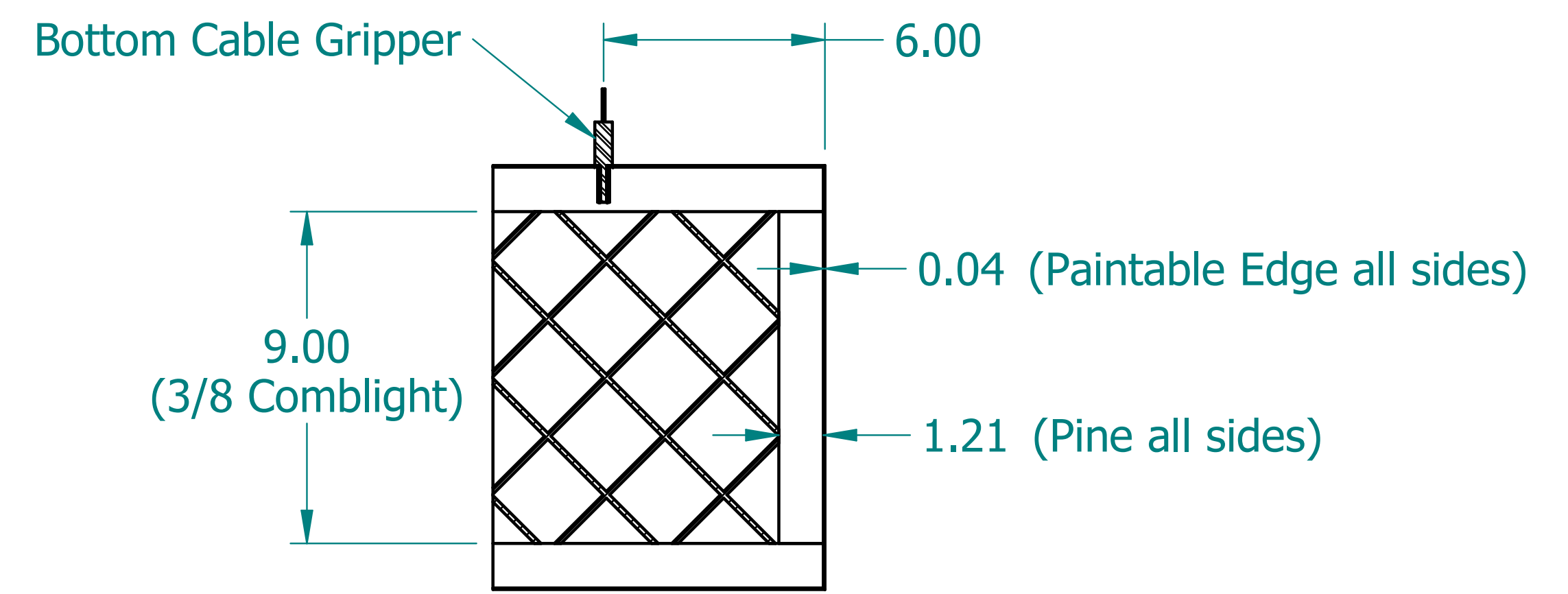

SECTION A-A

DETAIL B

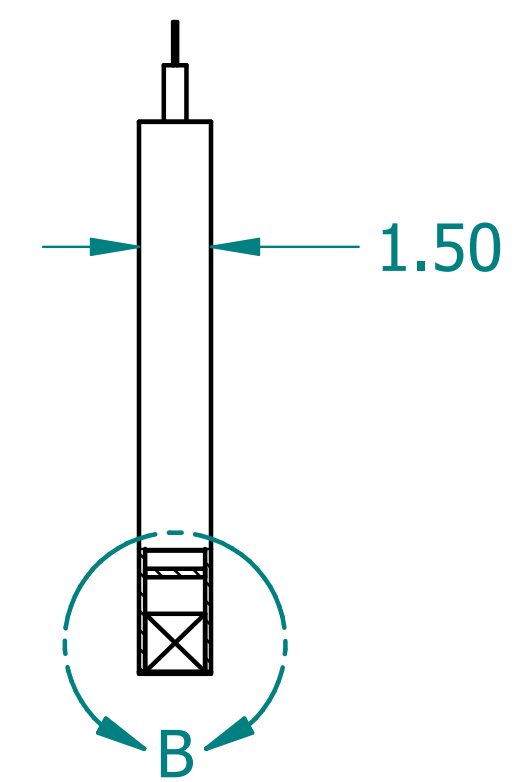
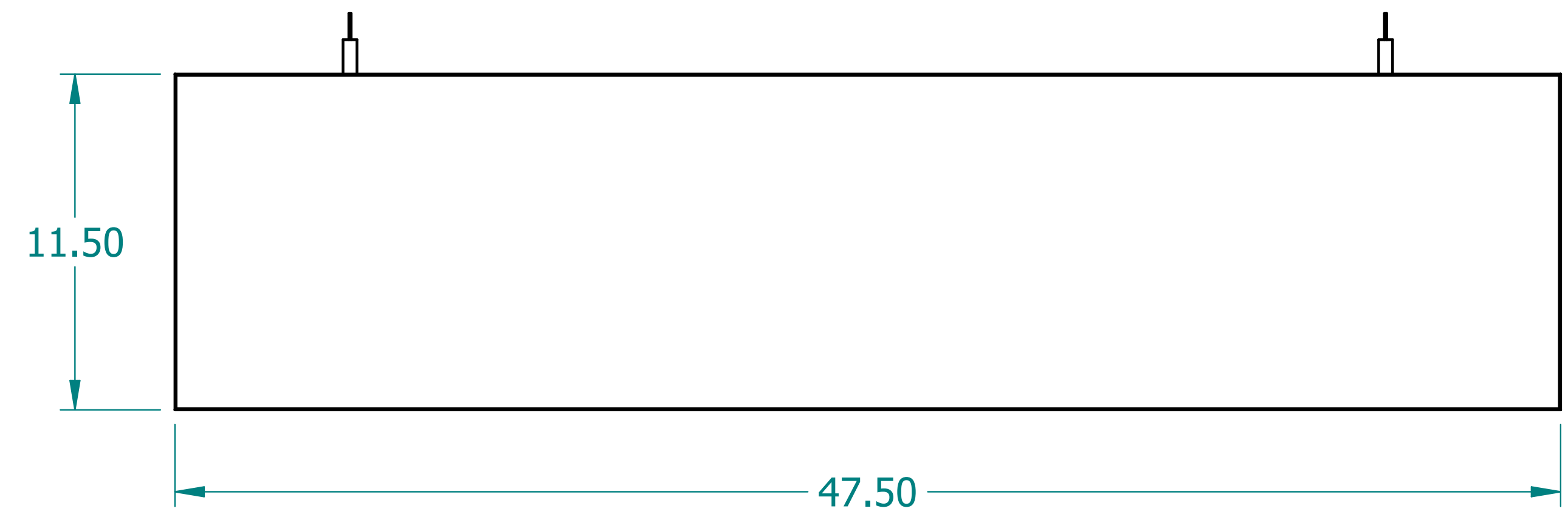
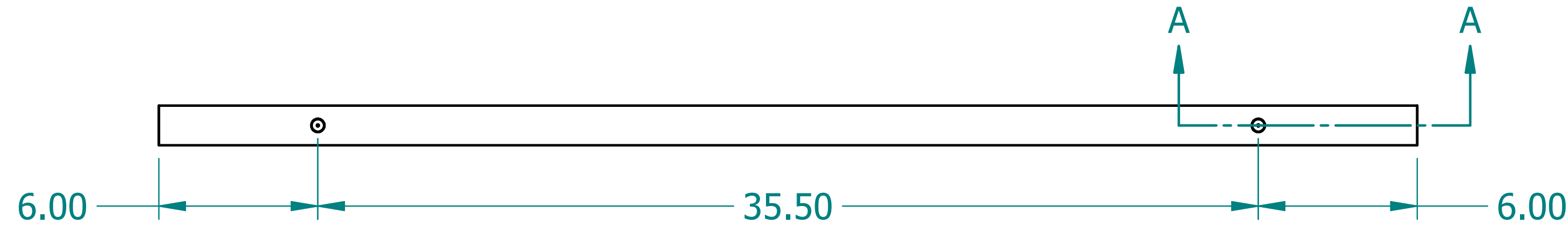
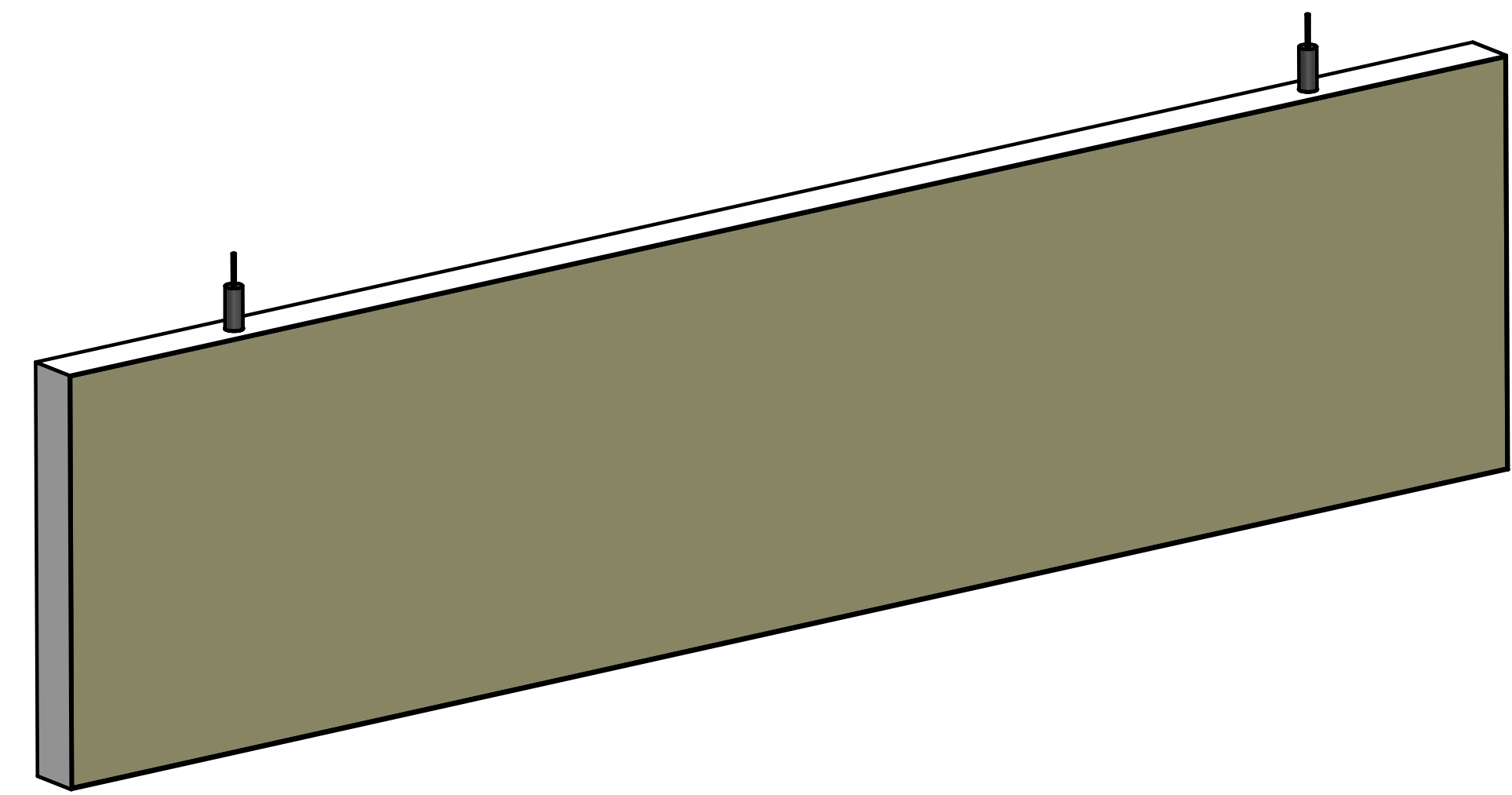
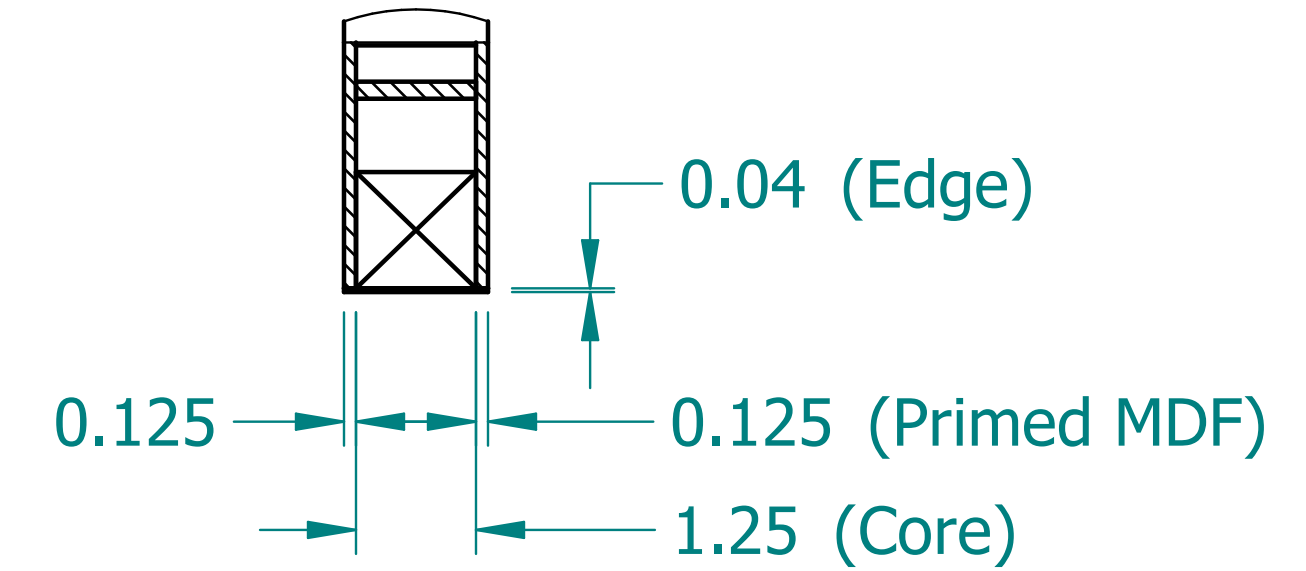

	NAME	DATE
DRAWN	SAI	03/11/20
ENG APPR	ERIC	03/11/20



UNLESS OTHERWISE SPECIFIED DIMENSIONS ARE IN 'INCHES'  
 ANGLES  $\pm 0.8^\circ$  ; 2 PL  $\pm 0.040$  ;  
 3 PL  $\pm 0.020$

TITLE <b>Paintable Beam</b>		
SUBTITLE 48"x12"x1.5"		
PART NO: Beam-028-PG	REV. 1.0	
SIZE: 34"x22"	SCALE: 0.25	SHEET 1 OF 1
FILE NAME: Paintable Beam (48.12.1.5).dft		