

REVISION HISTORY			
REV.	DESCRIPTION	DATE	APPROVED

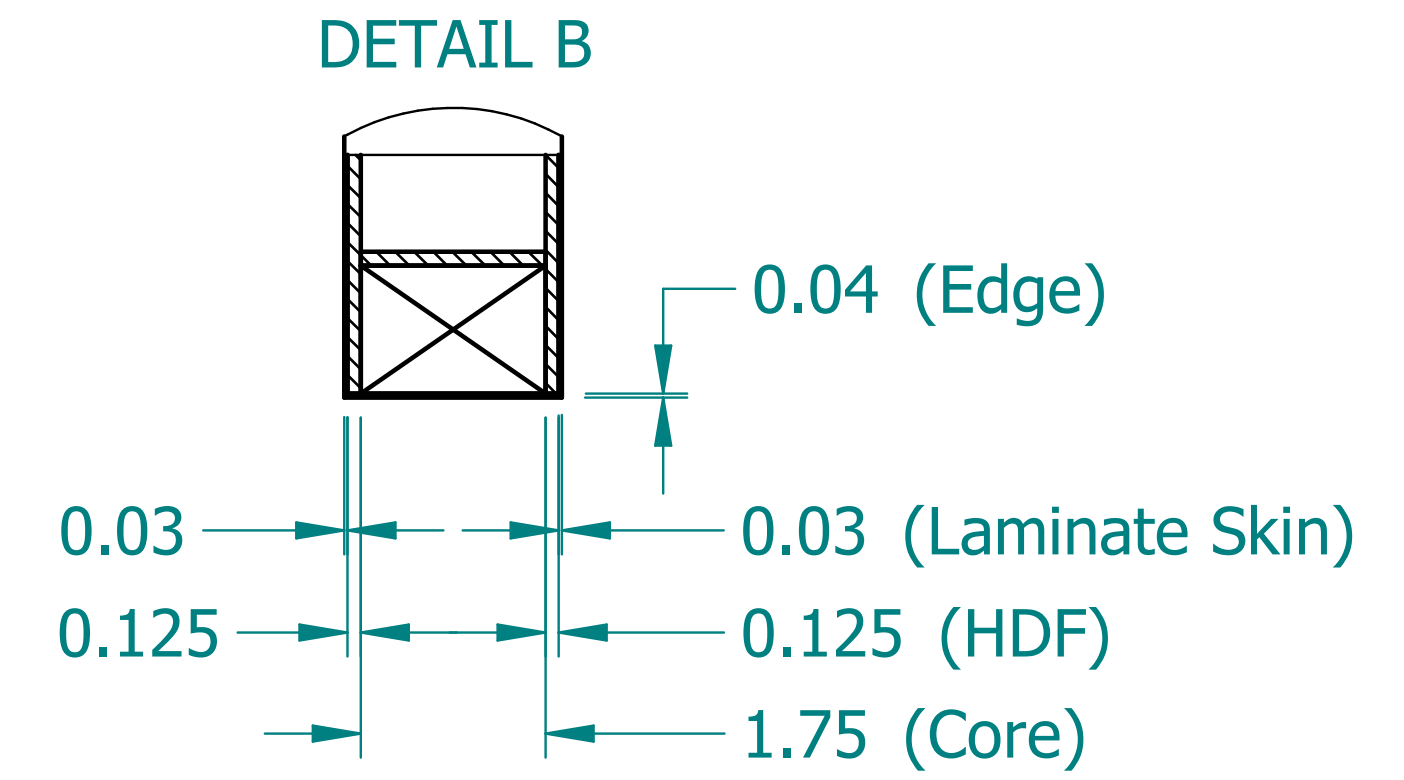
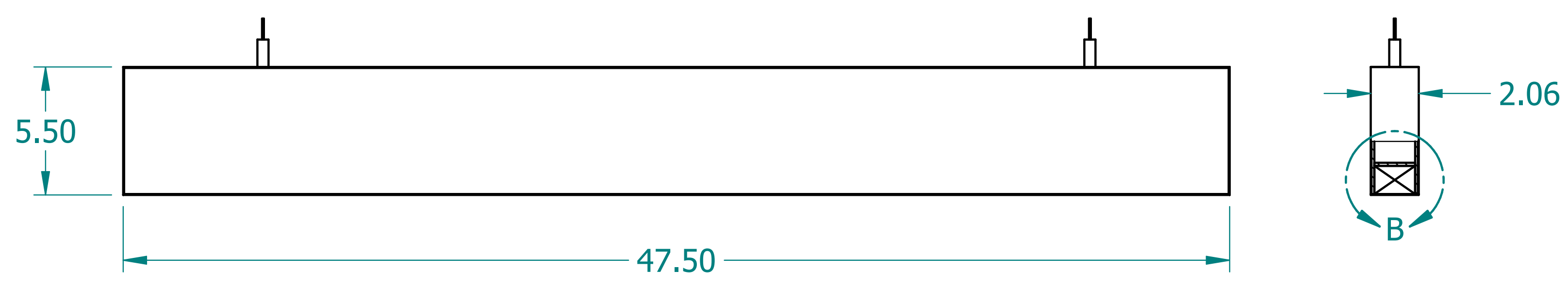
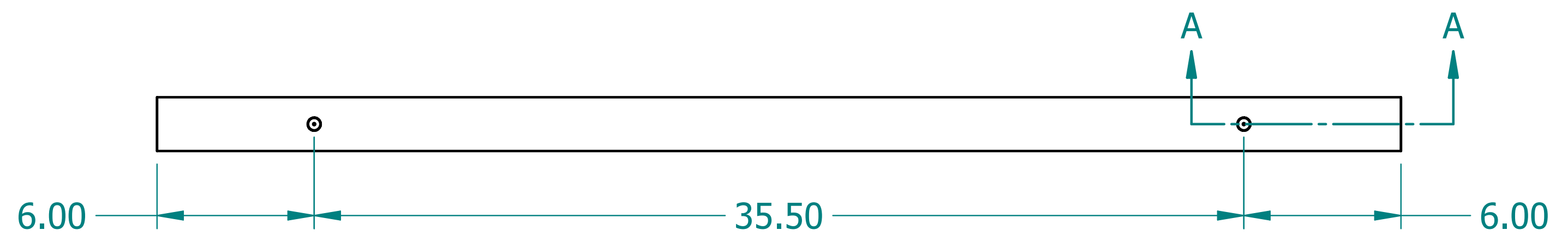
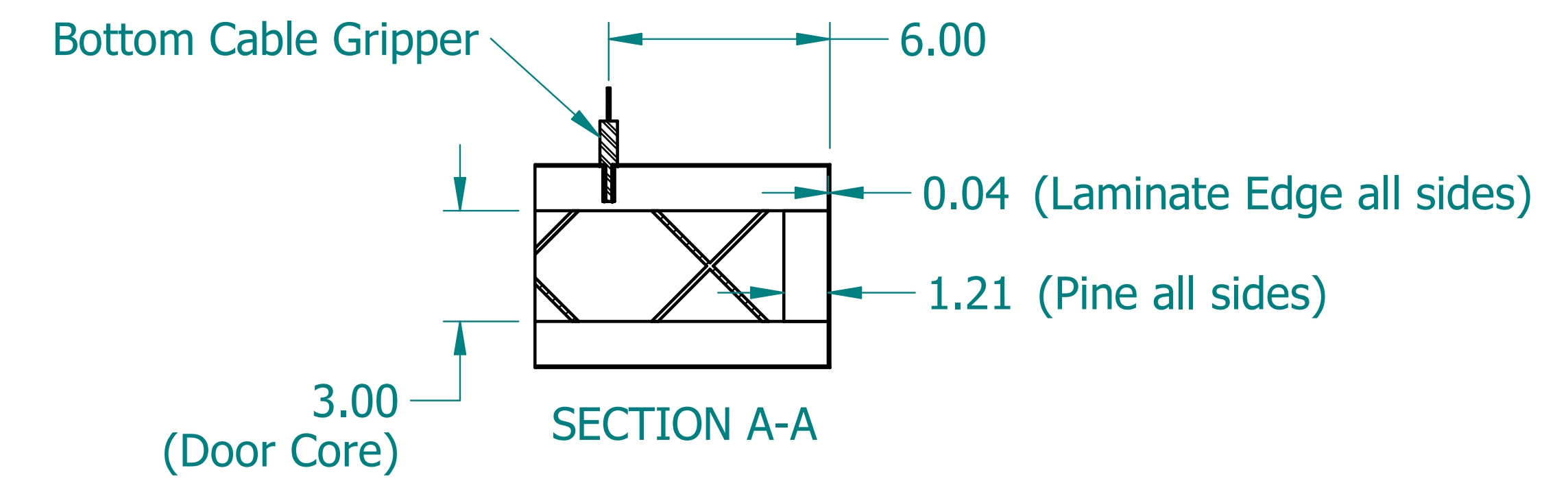
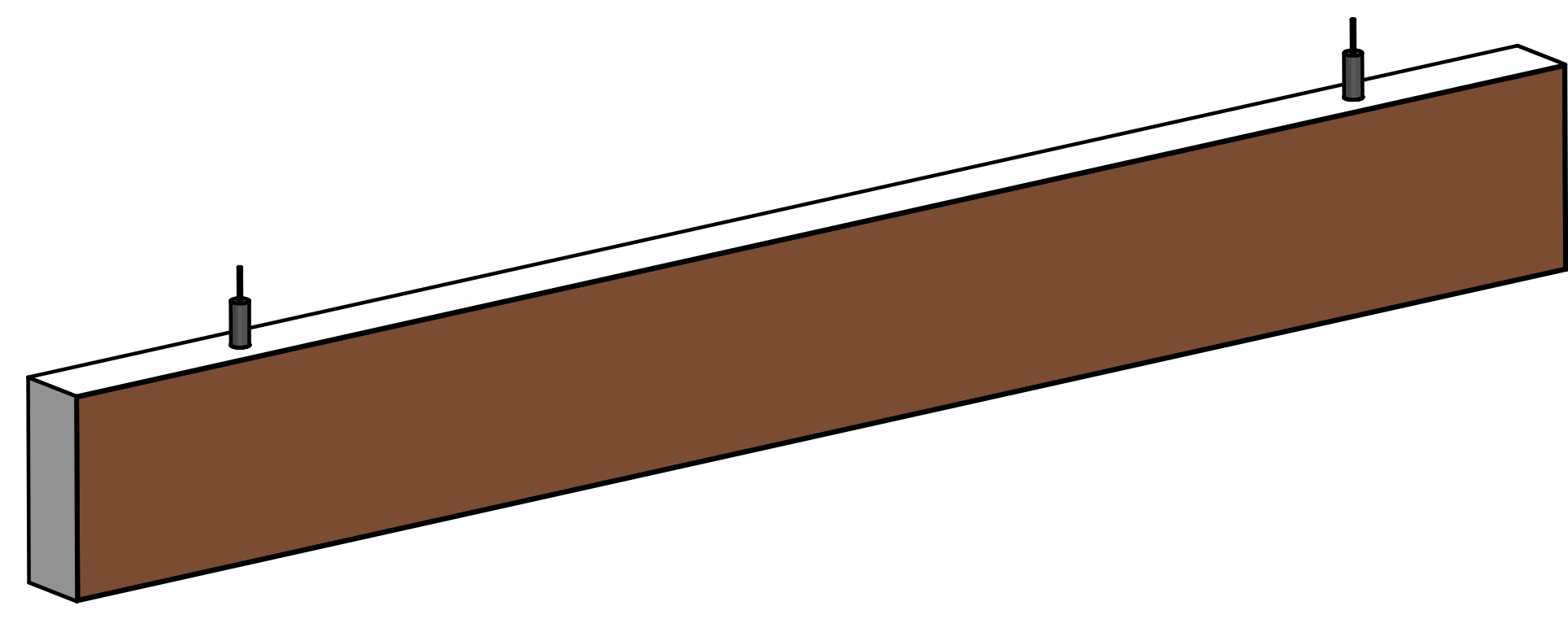

NAME	DATE	
DRAWN: SAI	03/11/20	
ENG APPR: ERIC	03/11/20	
		TITLE: Laminate Beam
UNLESS OTHERWISE SPECIFIED DIMENSIONS ARE IN 'INCHES' ANGLES $\pm 0.8^\circ$; 2 PL ± 0.040 ; 3 PL ± 0.020		SUBTITLE: 48"x6"x2"
		PART NO: Beam-029-XX
		REV: 1.0
		SIZE: 34"x22" SCALE: 0.25 SHEET 1 OF 1
		FILE NAME: Laminated Beam (48.6.2).dft