

REVISION HISTORY			
REV.	DESCRIPTION	DATE	APPROVED

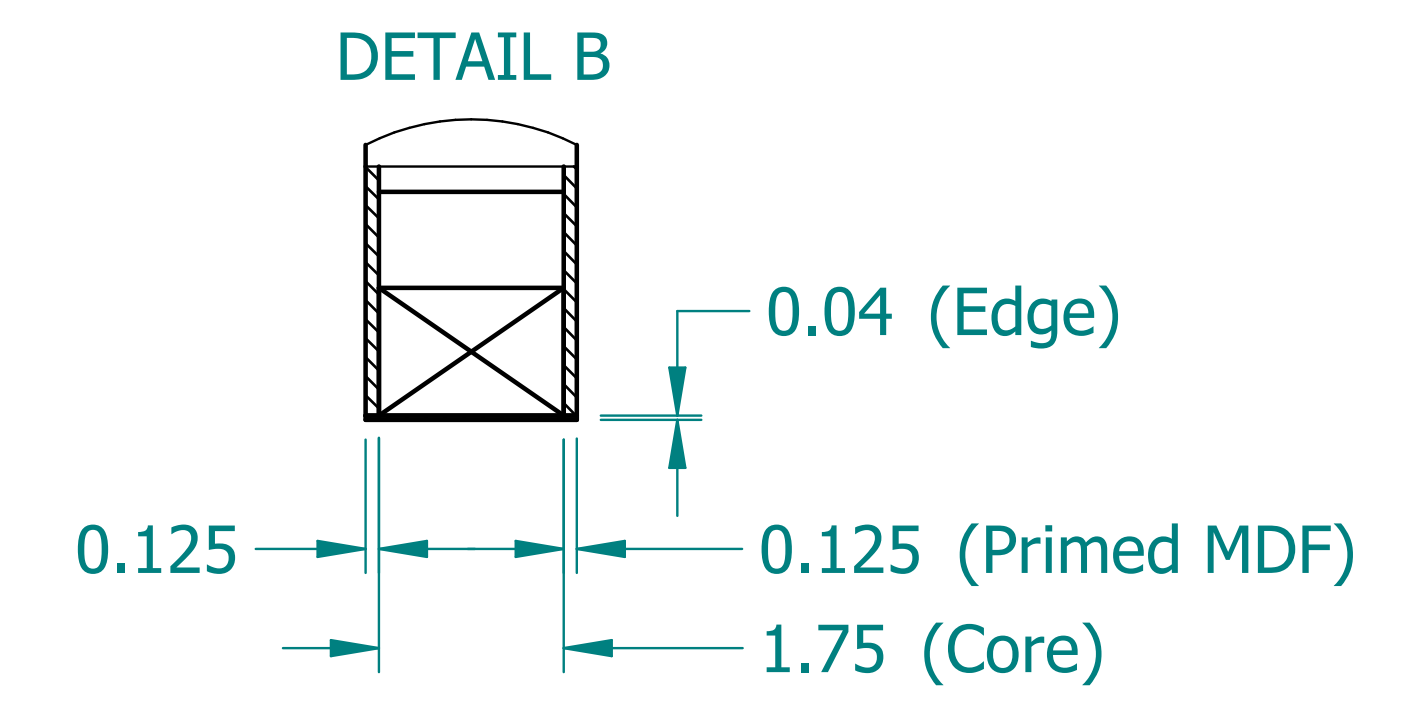

	NAME	DATE
DRAWN	SAI	03/11/20
ENG APPR	ERIC	03/11/20

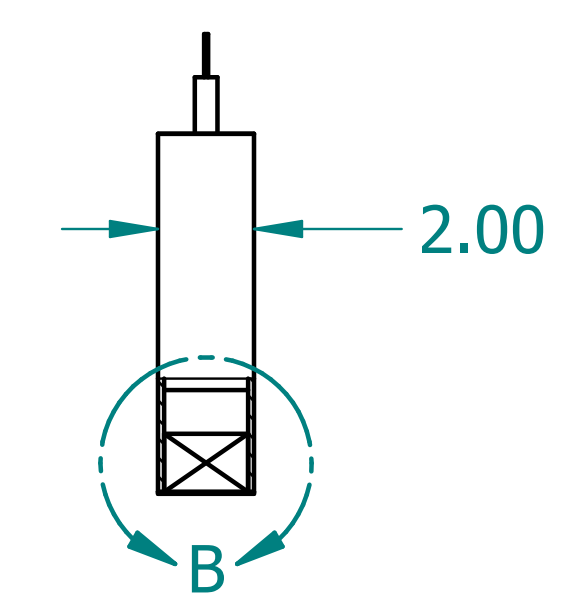
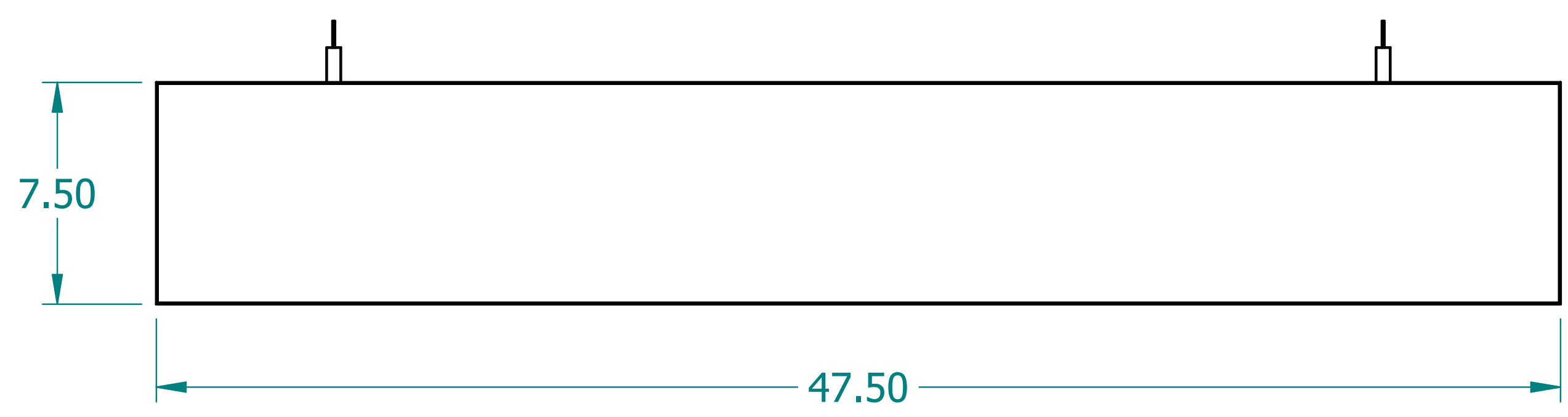
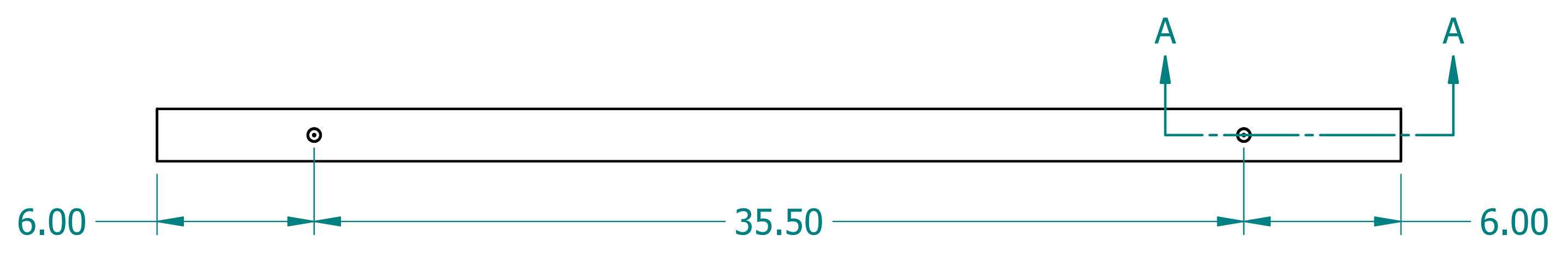
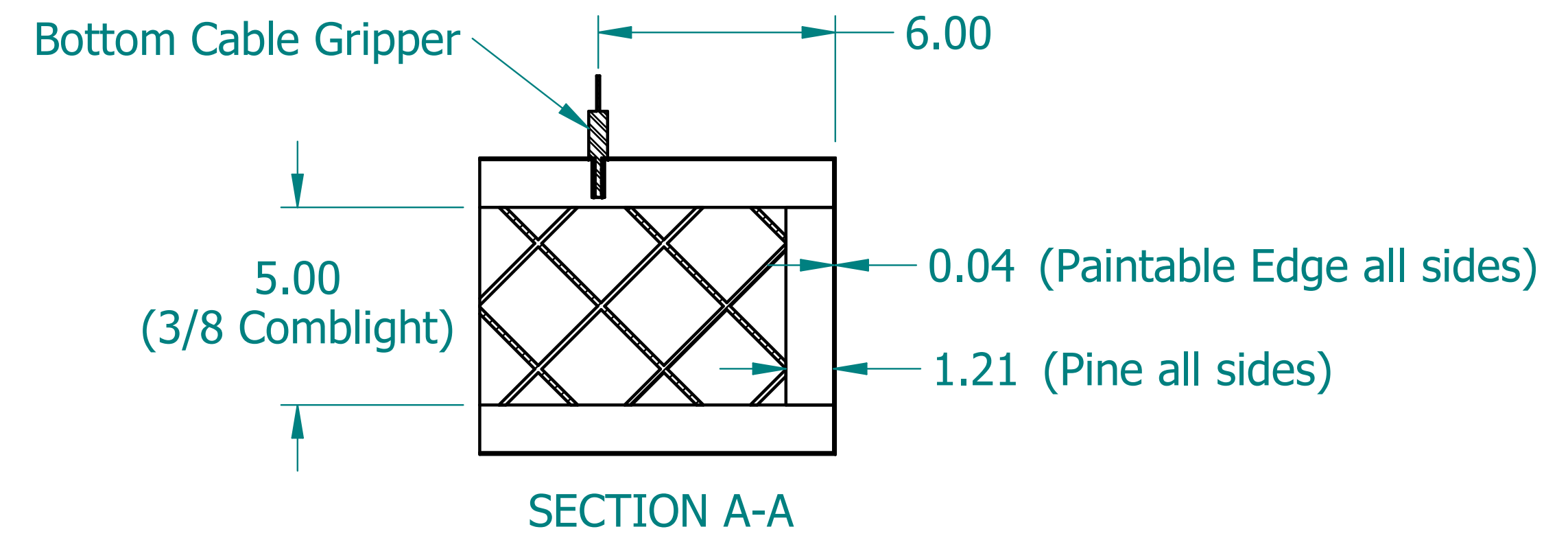
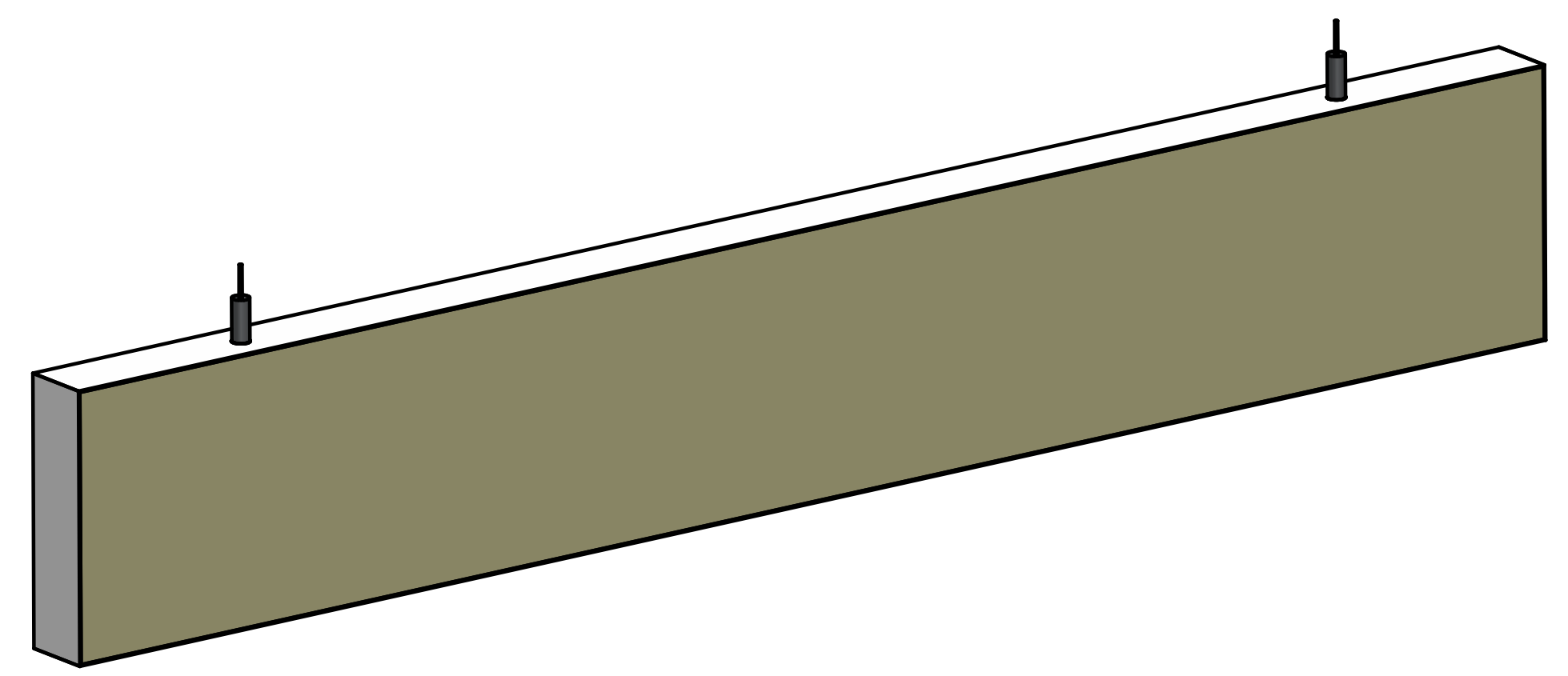

UNLESS OTHERWISE SPECIFIED DIMENSIONS ARE IN 'INCHES'
 ANGLES $\pm 0.8^\circ$; 2 PL ± 0.040 ;
 3 PL ± 0.020

TITLE Paintable Beam		
SUBTITLE 48"x8"x2"		
PART NO: Beam-030-PG	REV. 1.0	
SIZE: 34"x22"	SCALE: 0.25	SHEET 1 OF 1
FILE NAME: Paintable Beam (48.8.2).dft		