

REVISION HISTORY			
REV.	DESCRIPTION	DATE	APPROVED

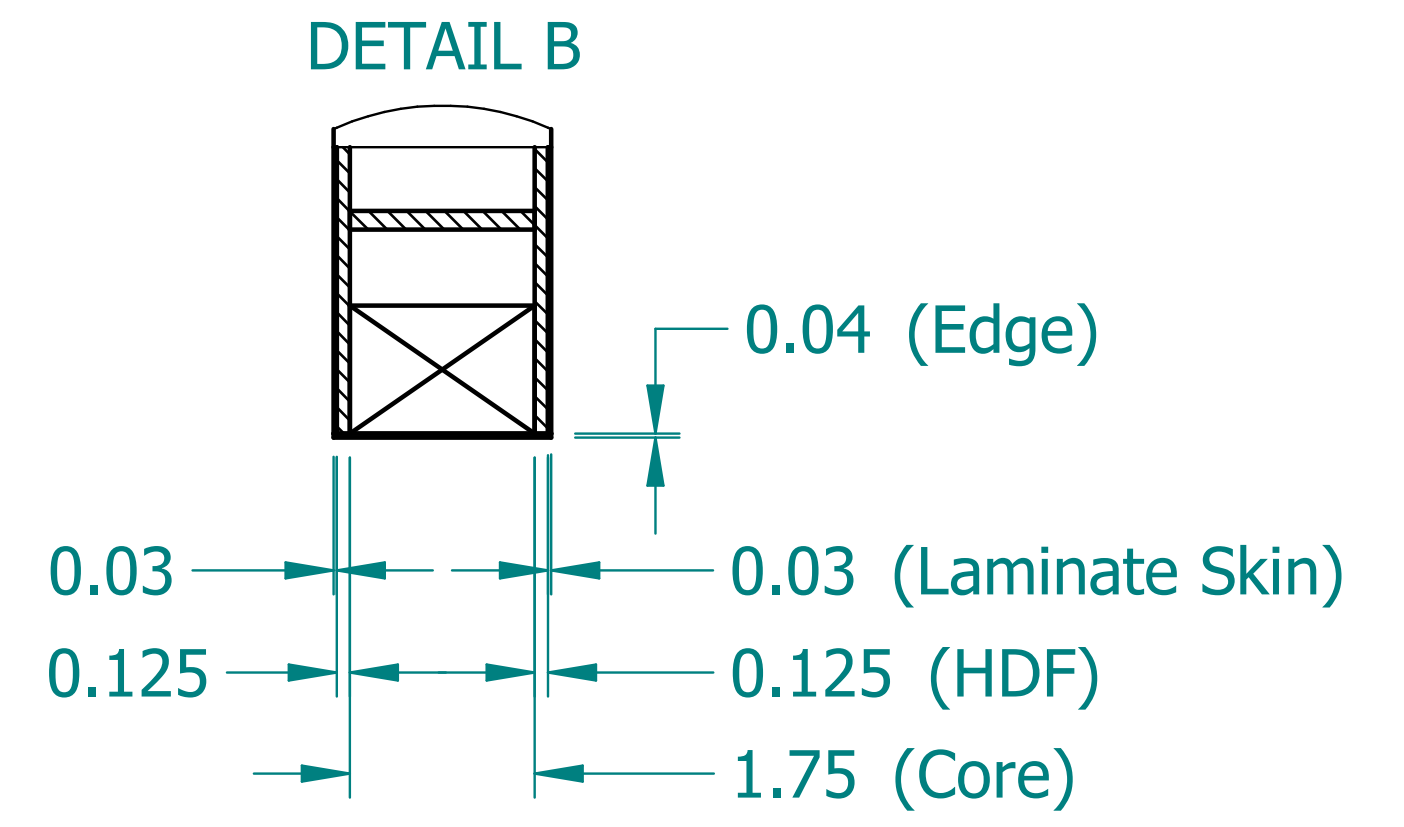

	NAME	DATE
DRAWN	SAI	03/11/20
ENG APPR	ERIC	03/11/20

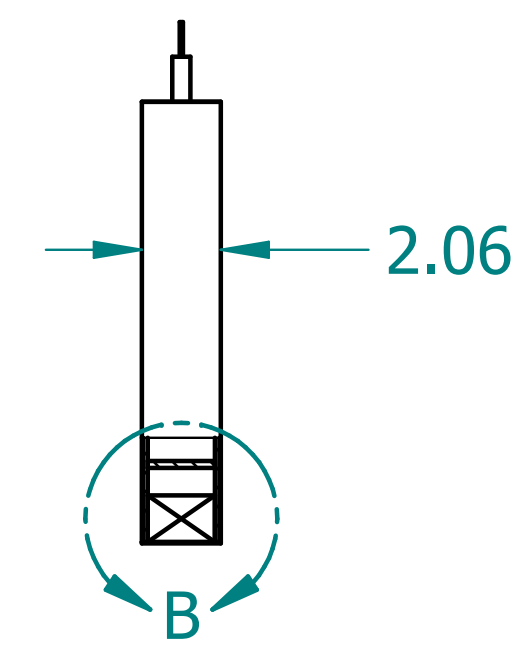
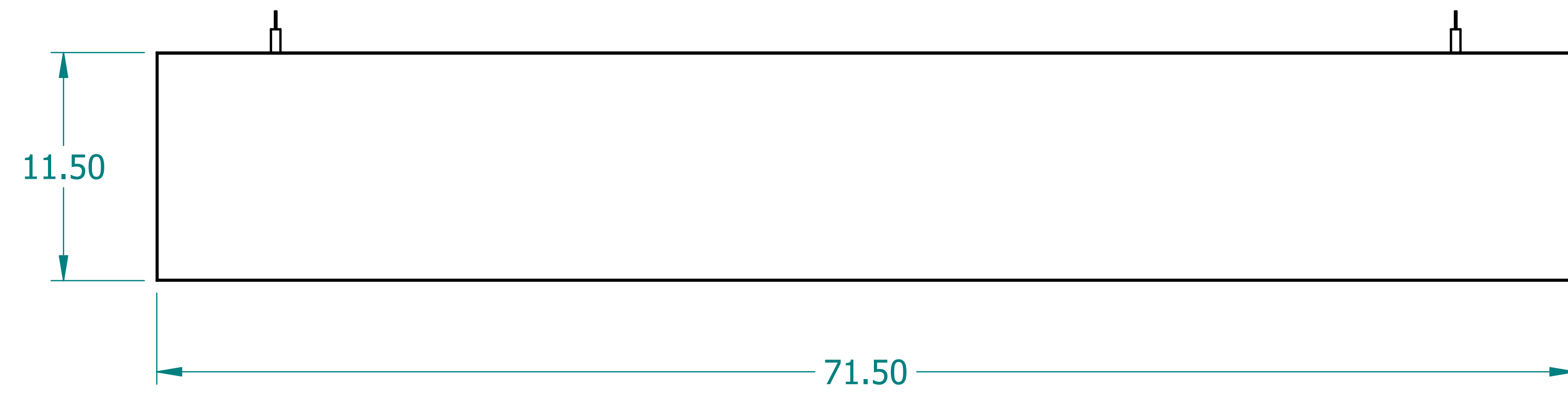
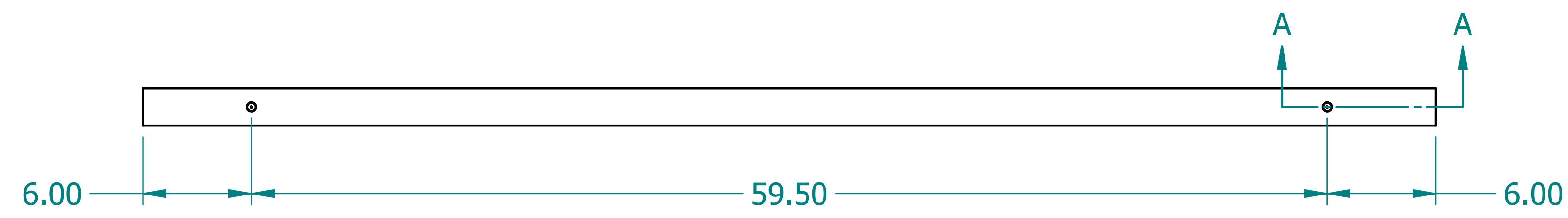
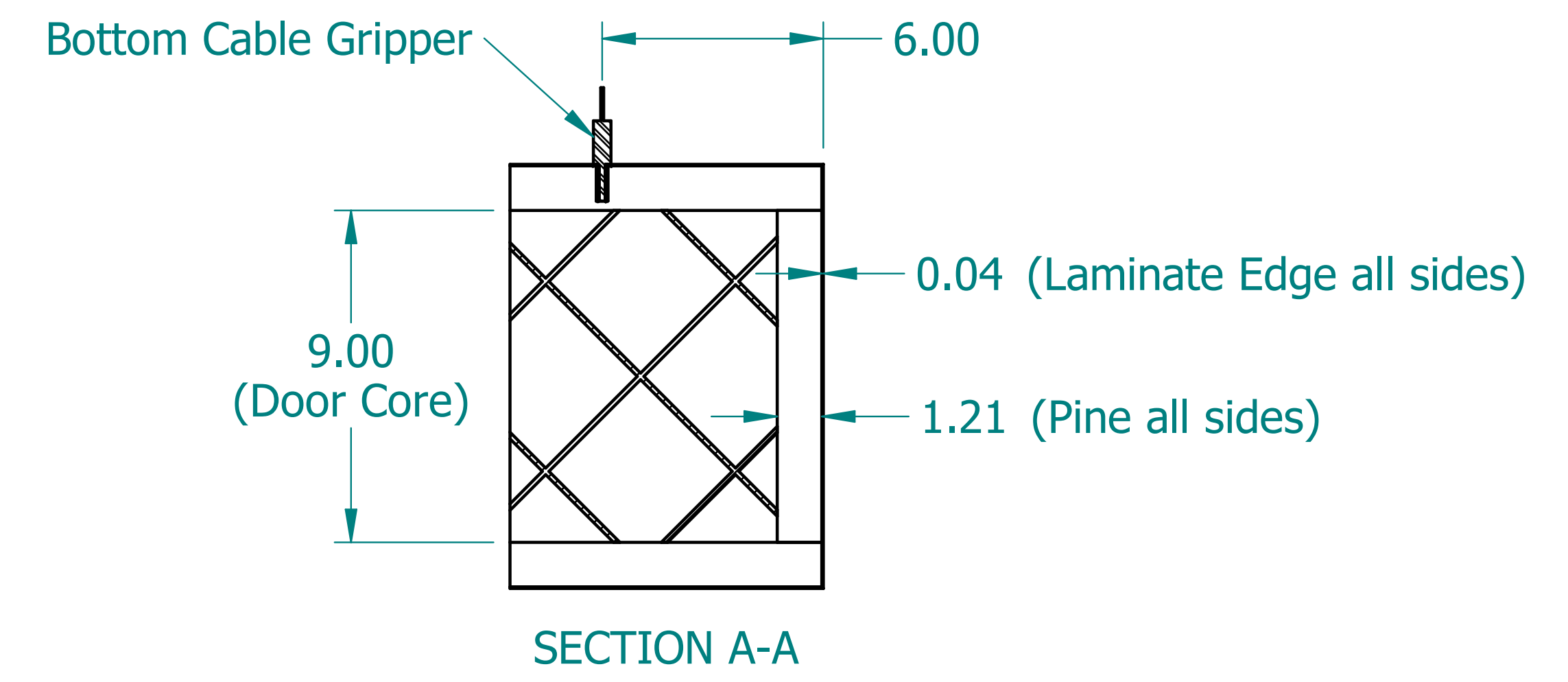
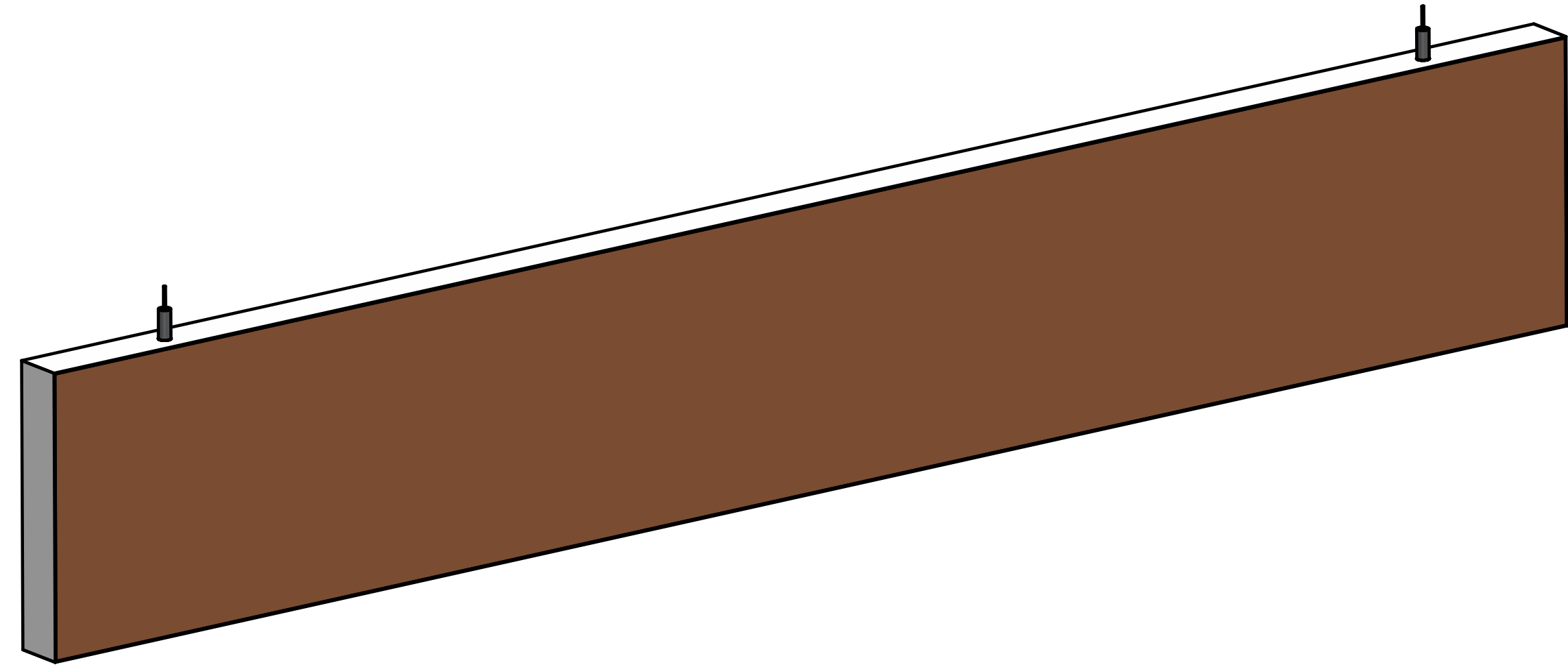

UNLESS OTHERWISE SPECIFIED DIMENSIONS ARE IN 'INCHES'
 ANGLES $\pm 0.8^\circ$; 2 PL ± 0.040 ;
 3 PL ± 0.020

TITLE Laminate Beam		
SUBTITLE 72"x12"x2"		
PART NO: Beam-056-XX	REV. 1.0	
SIZE: 34"x22"	SCALE: 0.20	SHEET 1 OF 1
FILE NAME: Laminated Beam (72.12.2).dft		