

REVISION HISTORY			
REV.	DESCRIPTION	DATE	APPROVED

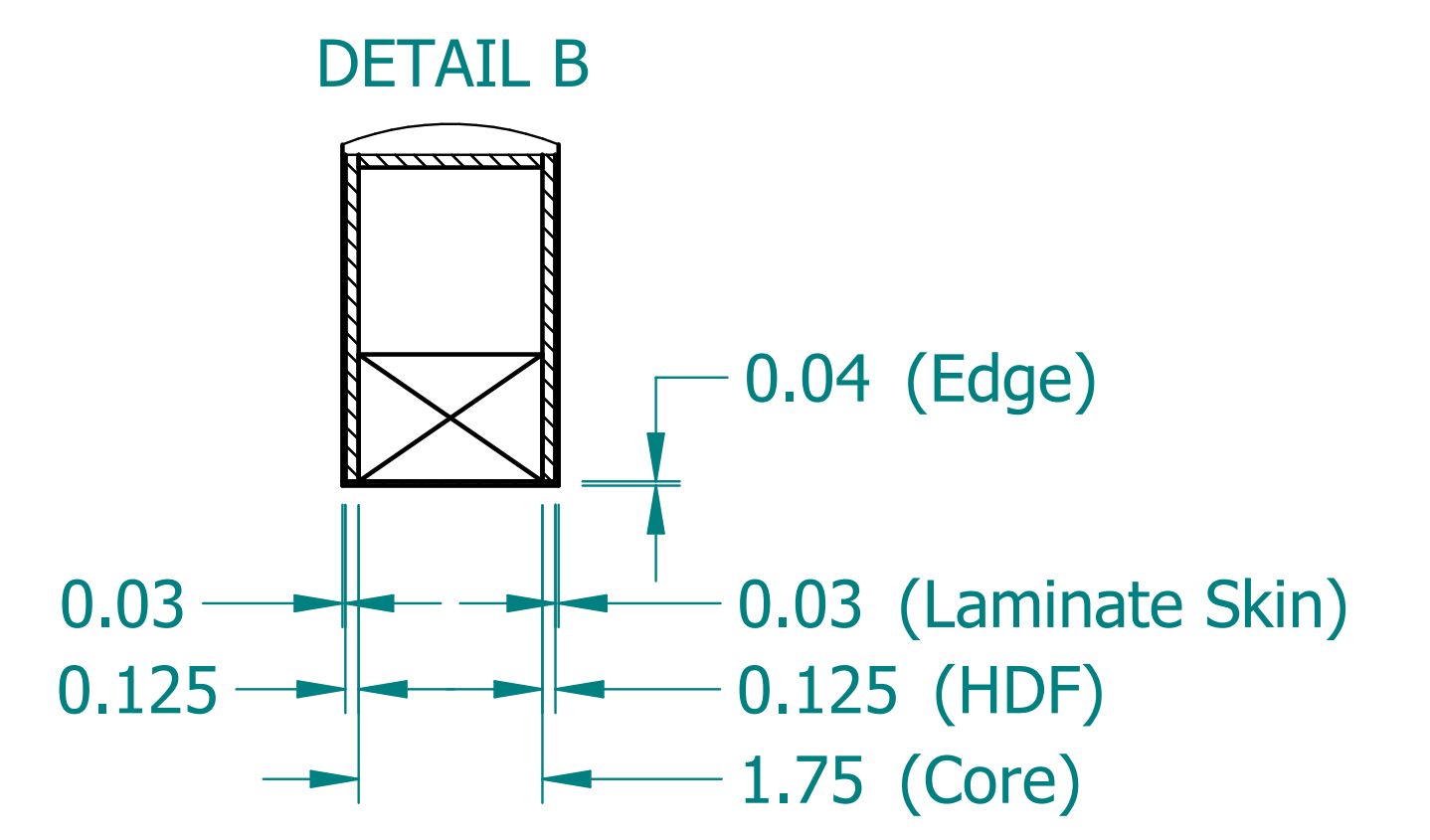
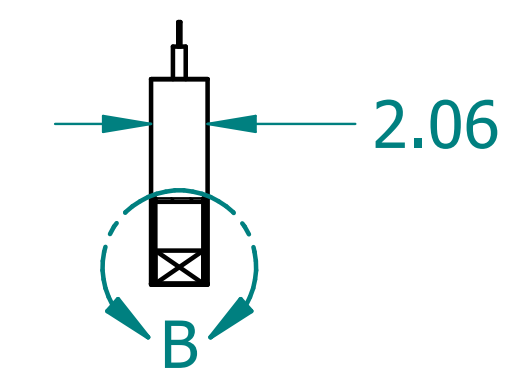
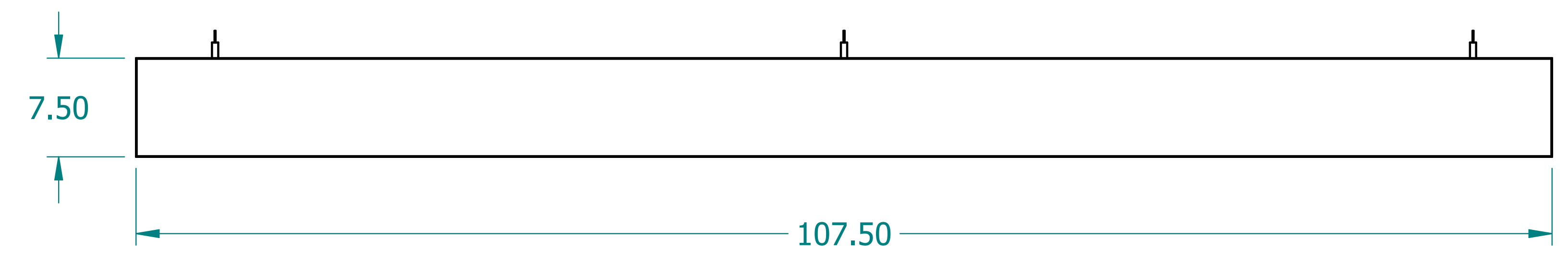
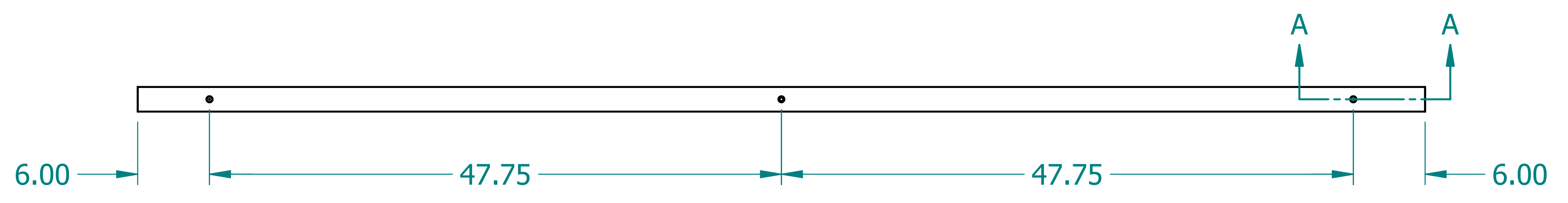
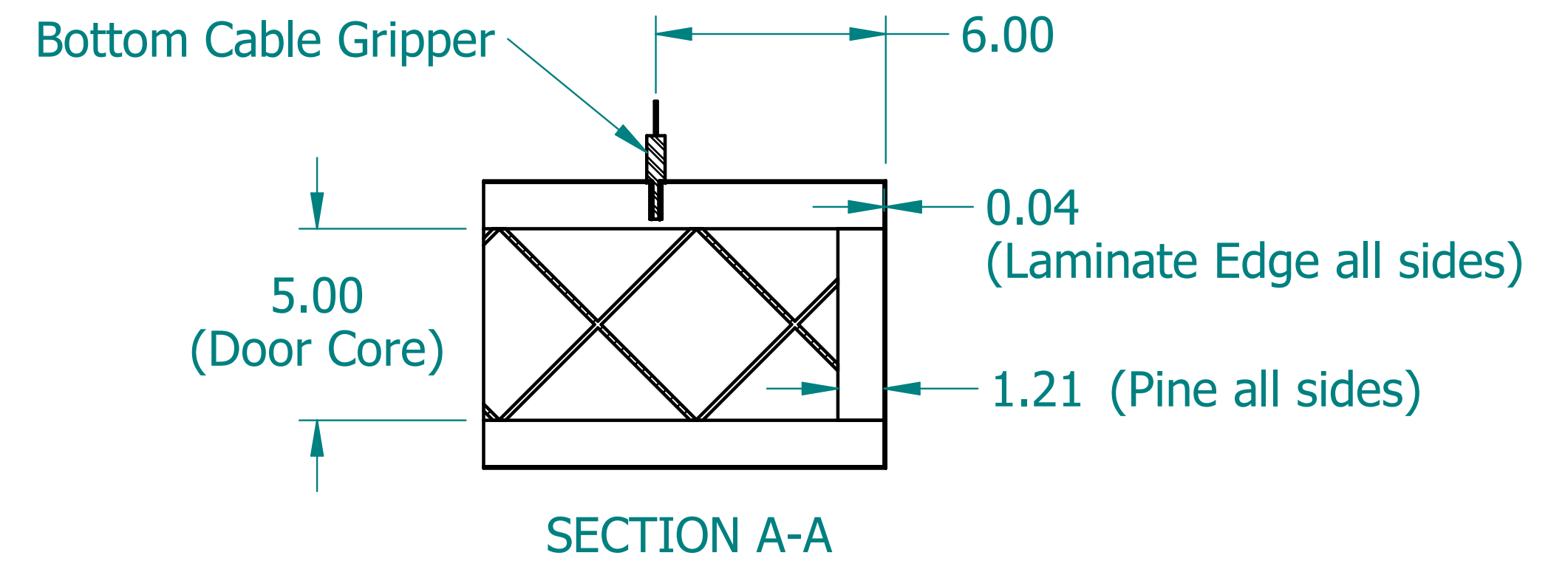
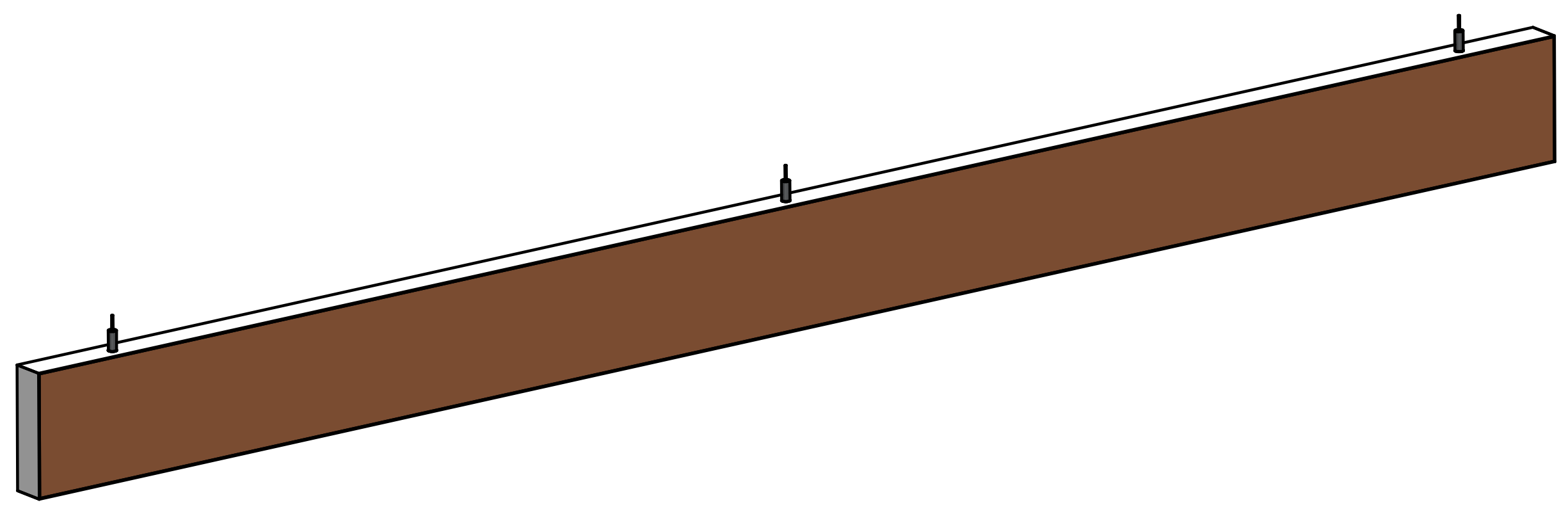

NAME	DATE	
DRAWN: SAI	03/11/20	
ENG APPR: ERIC	03/11/20	
		TITLE: Laminated Beam
UNLESS OTHERWISE SPECIFIED DIMENSIONS ARE IN 'INCHES'		SUBTITLE: 108"x8"x2"
ANGLES ±0.8° ; 2 PL ±0.040 ; 3 PL ±0.020		PART NO: Beam-090-XX REV: 1.0
		SIZE: 34"x22" SCALE: 0.14 SHEET 1 OF 1
		FILE NAME: Laminated Beam (108.8.2).dft