

REVISION HISTORY			
REV.	DESCRIPTION	DATE	APPROVED

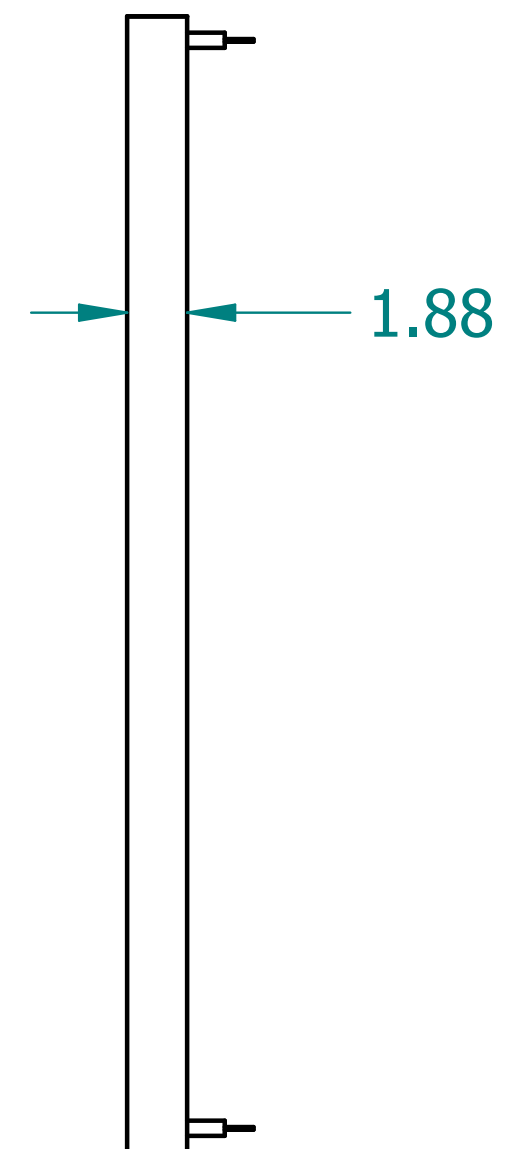

SECTION A-A

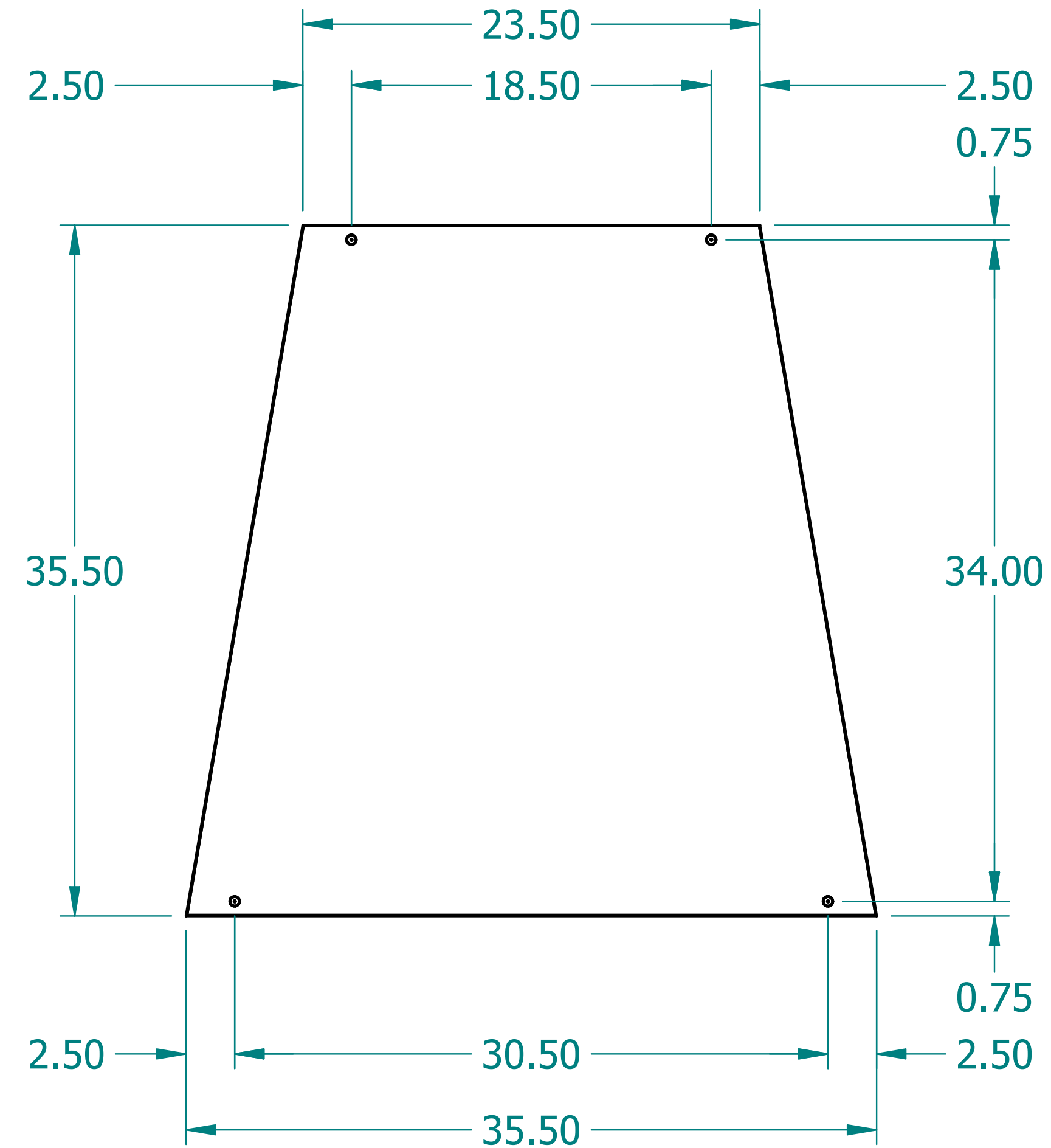
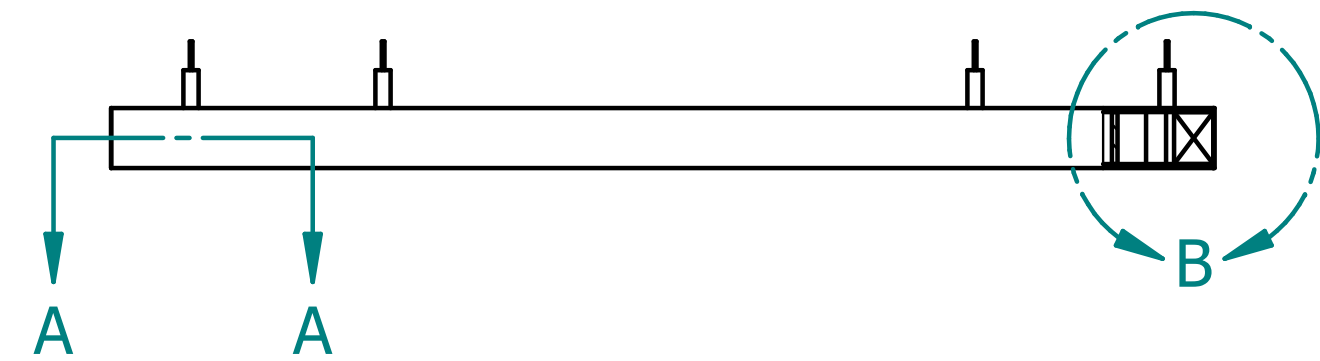
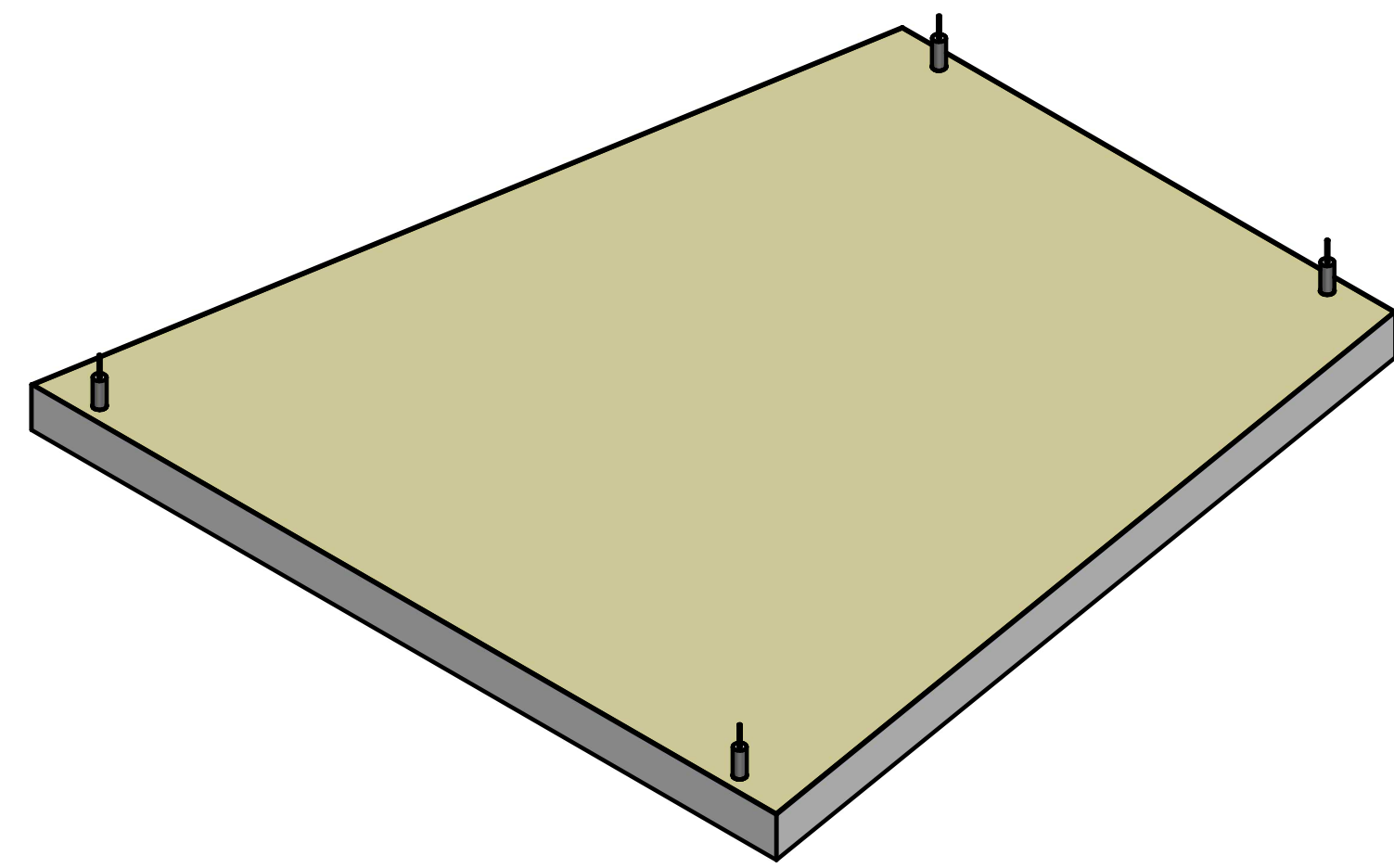
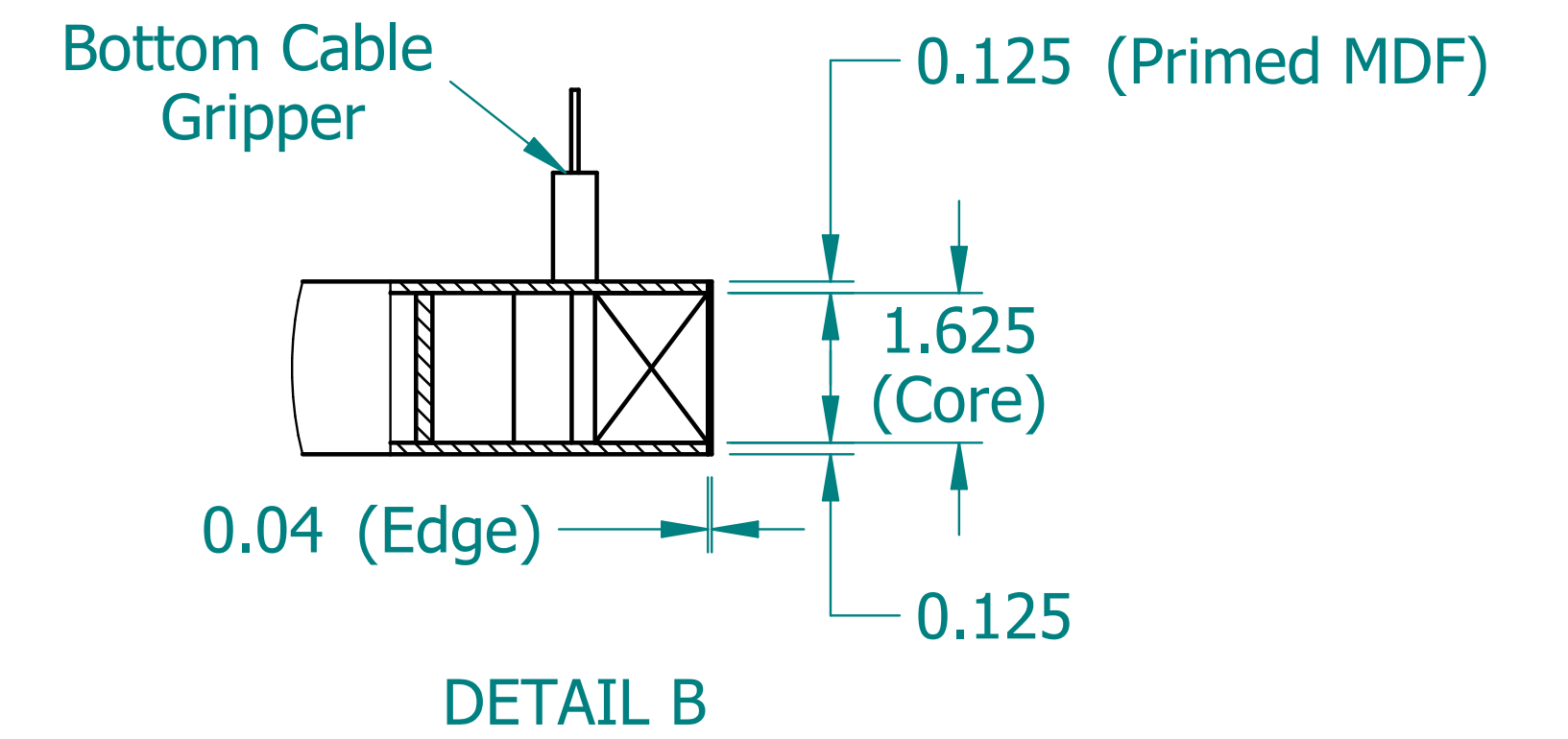
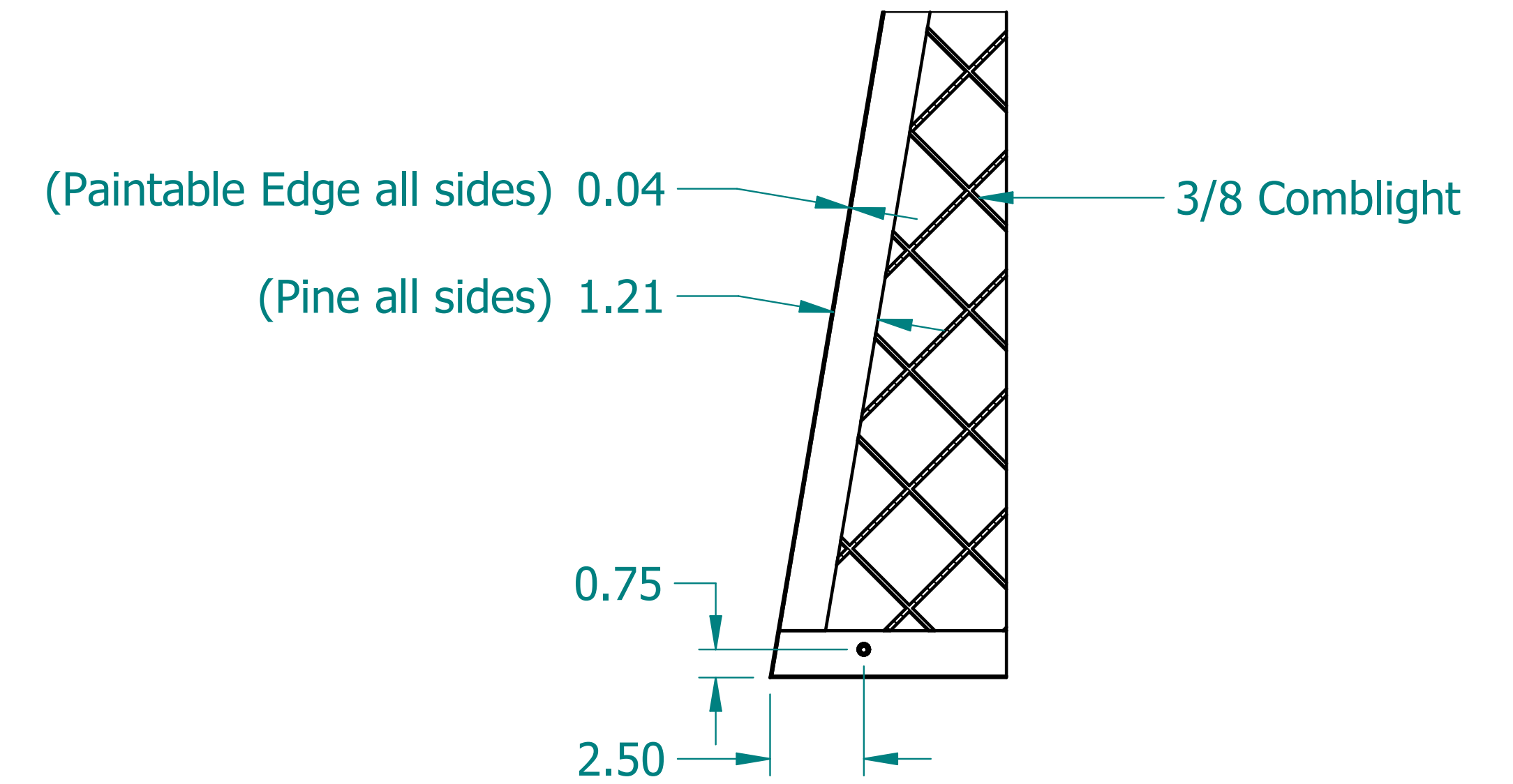

NAME	DATE	
DRAWN: SAI	05/01/20	
ENG APPR: ERIC	05/01/20	
		TITLE: Paintable Shape: Trapezoid
UNLESS OTHERWISE SPECIFIED DIMENSIONS ARE IN 'INCHES'		SUBTITLE: 36"x36"x2"
ANGLES ±0.8° ; 2 PL ±0.040 ; 3 PL ±0.020		PART NO: Shape-4-03-PG REV: 1.0
		SIZE: 34"x22" SCALE: 0.17 SHEET 1 OF 1
		FILE NAME: Paintable Trapezoid (36.36.2).dft