

REVISION HISTORY

REV.	DESCRIPTION	DATE	APPROVED

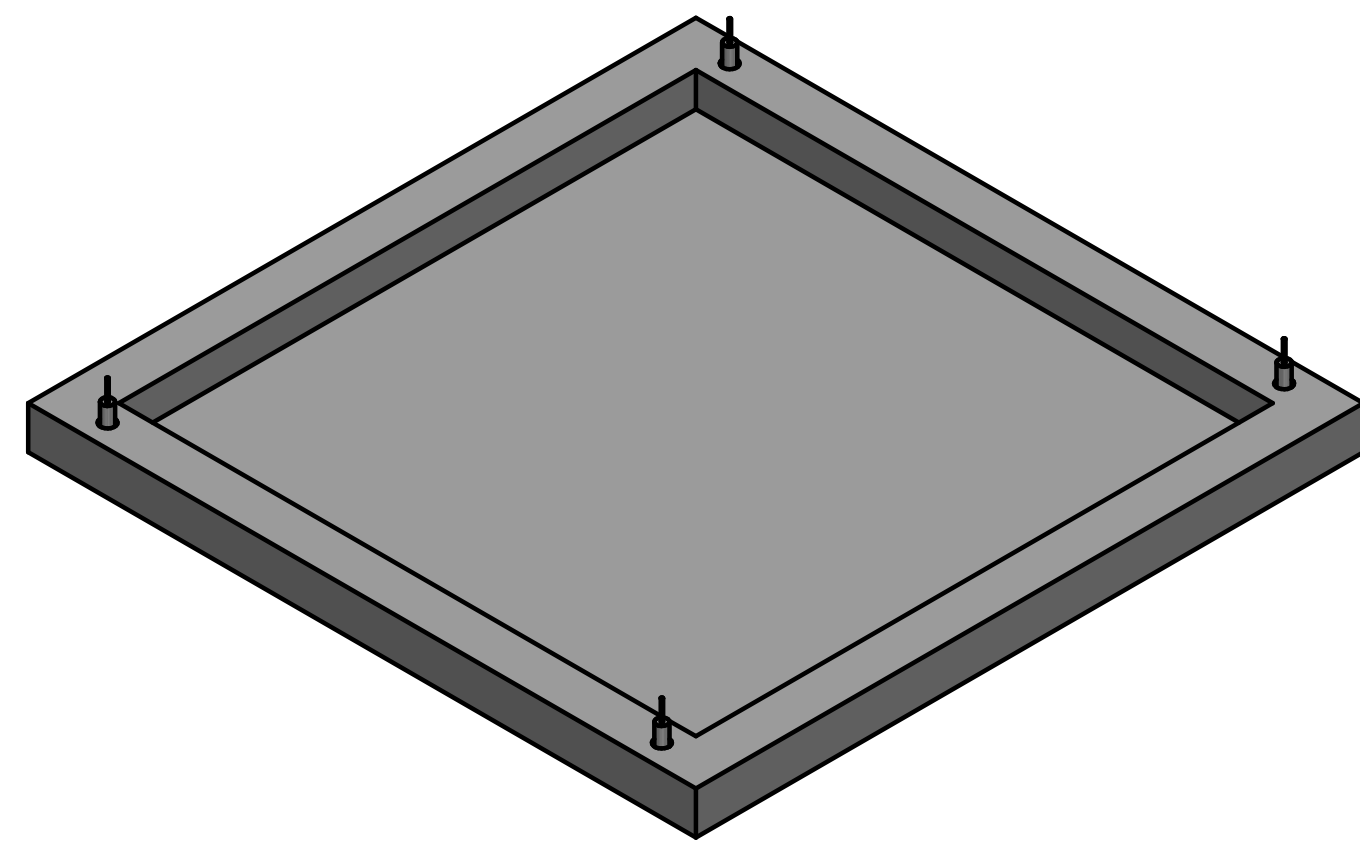

SECTION A-A

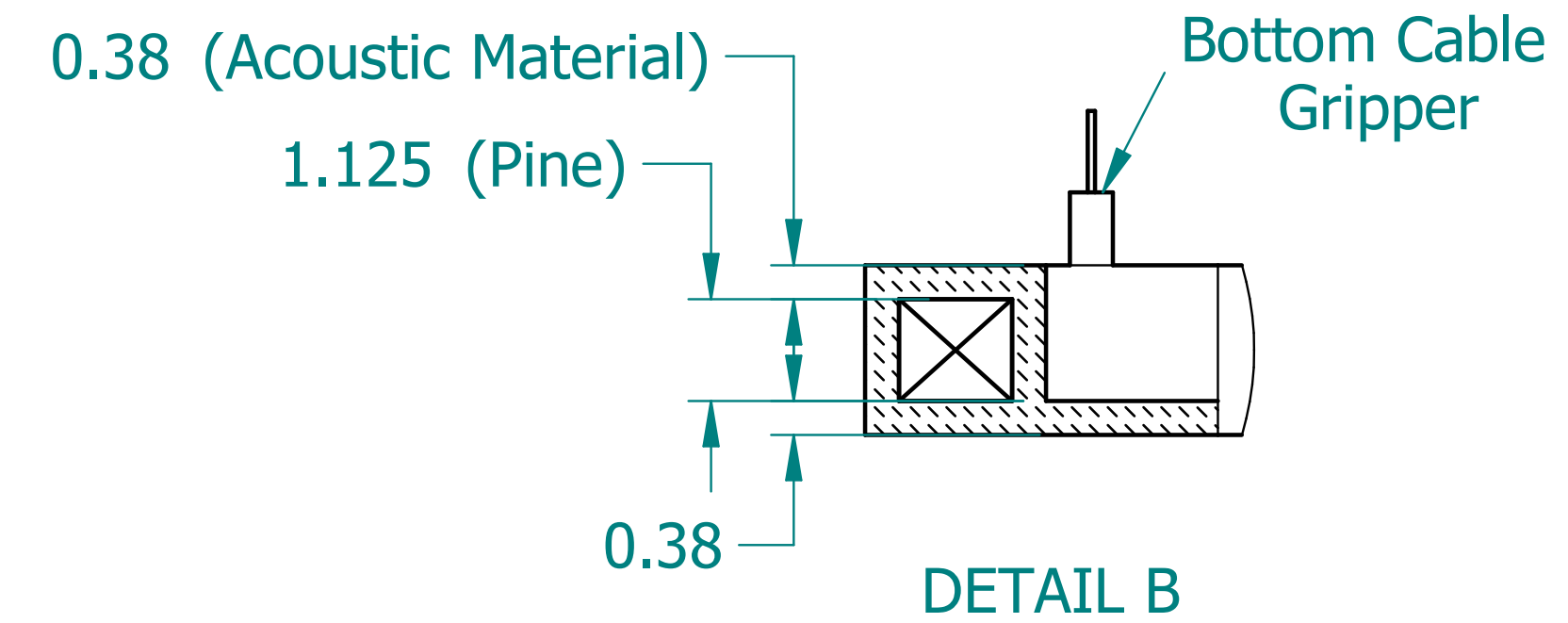
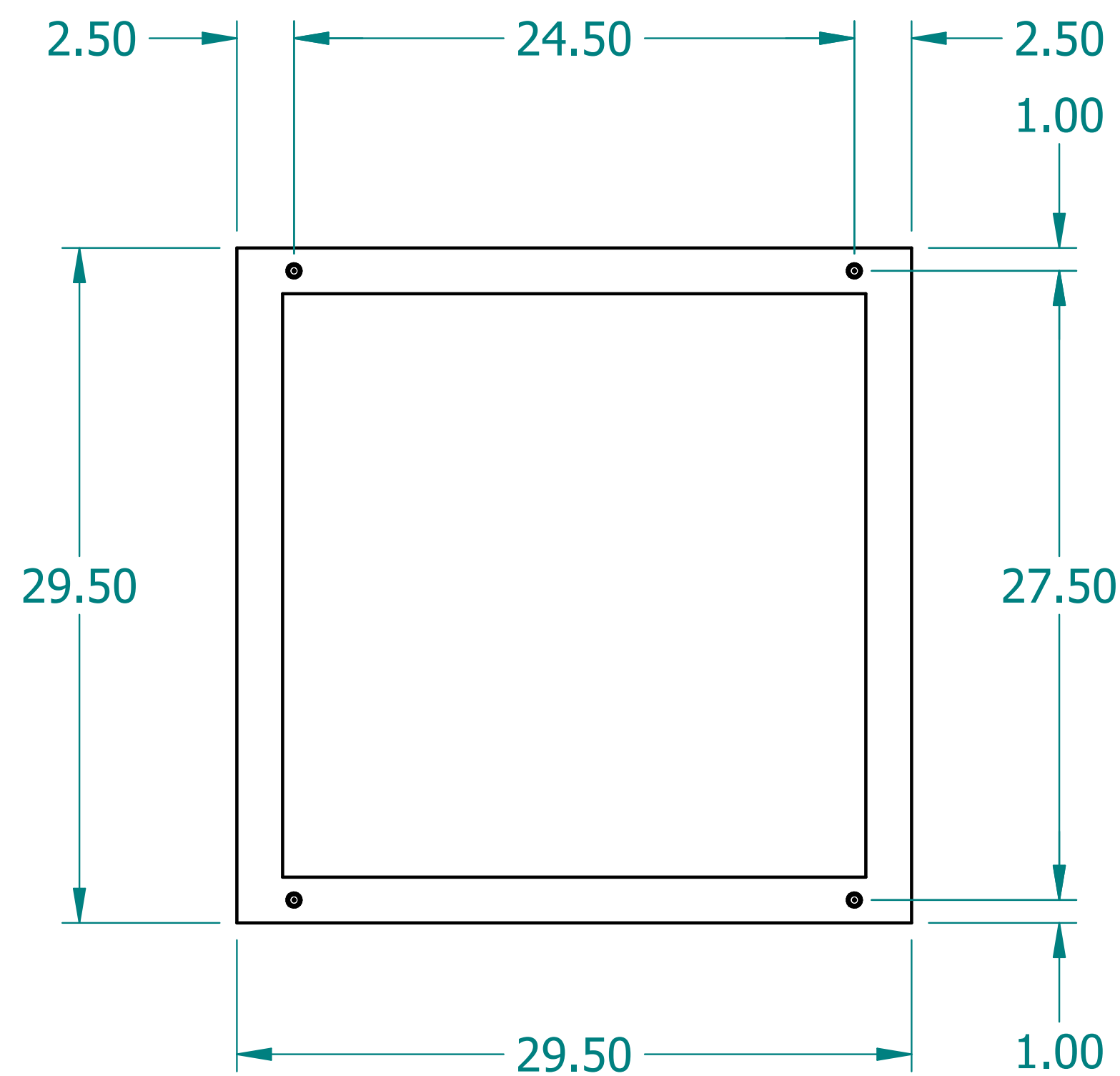
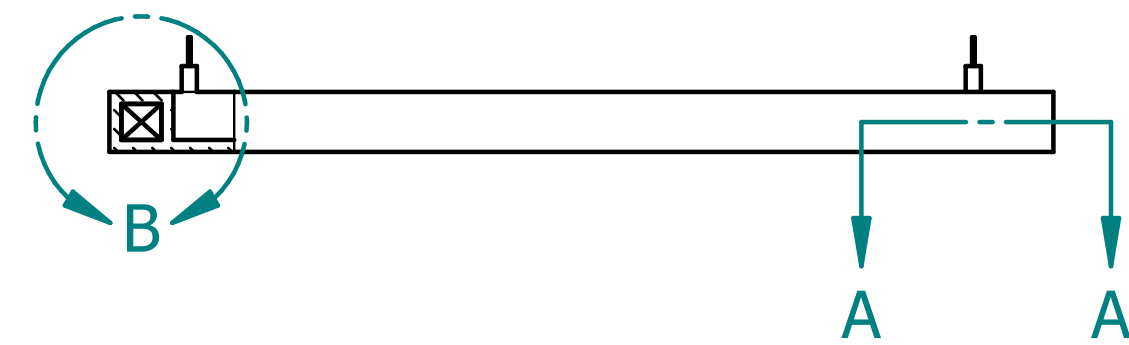
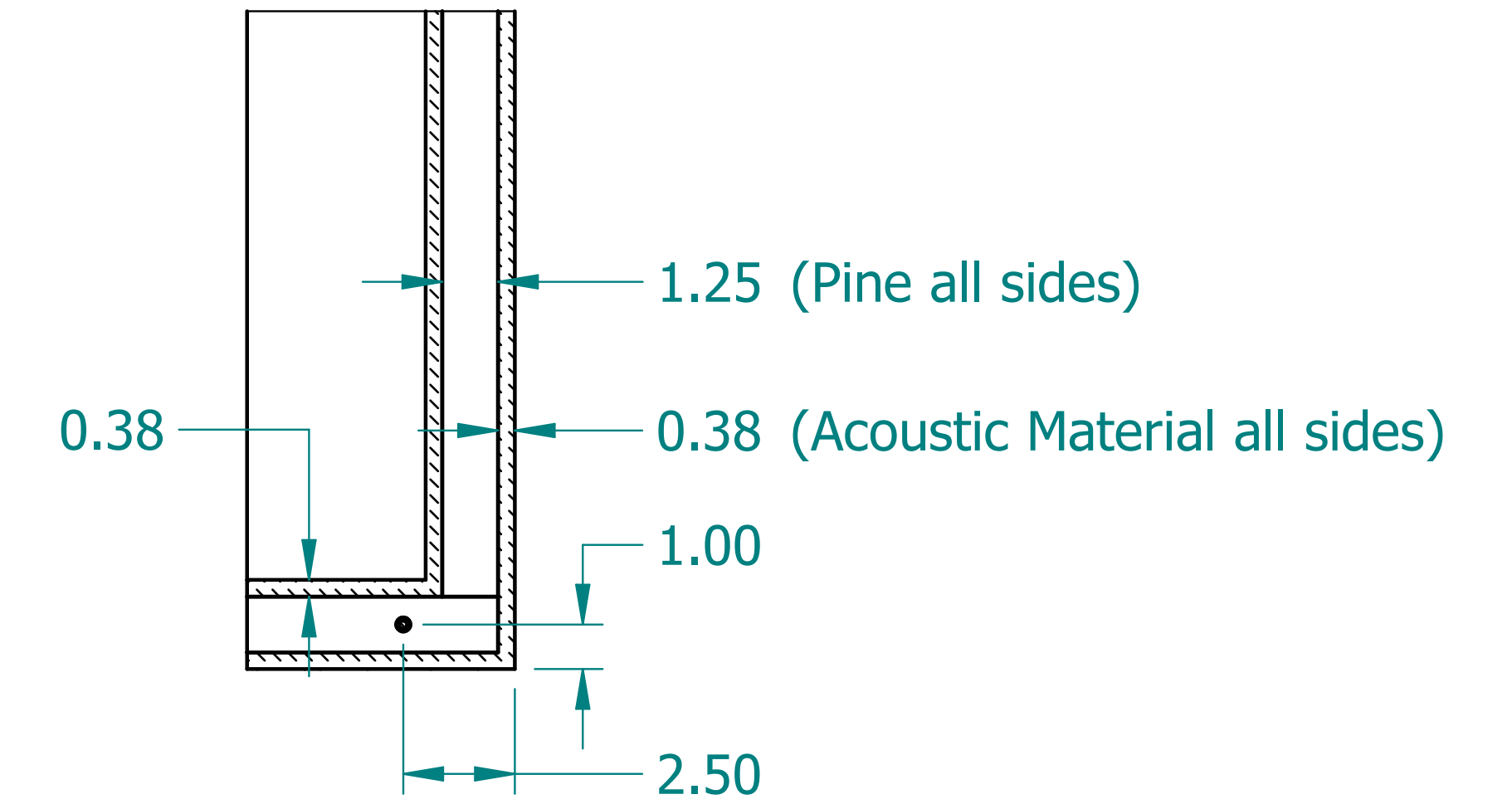

	NAME	DATE
DRAWN	SAI	03/03/20
ENG APPR	ERIC	03/03/20



UNLESS OTHERWISE SPECIFIED DIMENSIONS ARE IN 'INCHES'
 ANGLES $\pm 0.8^\circ$; 2 PL ± 0.040 ;
 3 PL ± 0.020

TITLE Acoustic Shape: Square		
SUBTITLE 30"x30"x2"		
PART NO: AShape-1-02-XX	REV. 1.0	
SIZE: 34"x22"	SCALE: 0.17	SHEET 1 OF 1
FILE NAME: Acoustic Square (30.30.2).dft		