

REVISION HISTORY			
REV.	DESCRIPTION	DATE	APPROVED

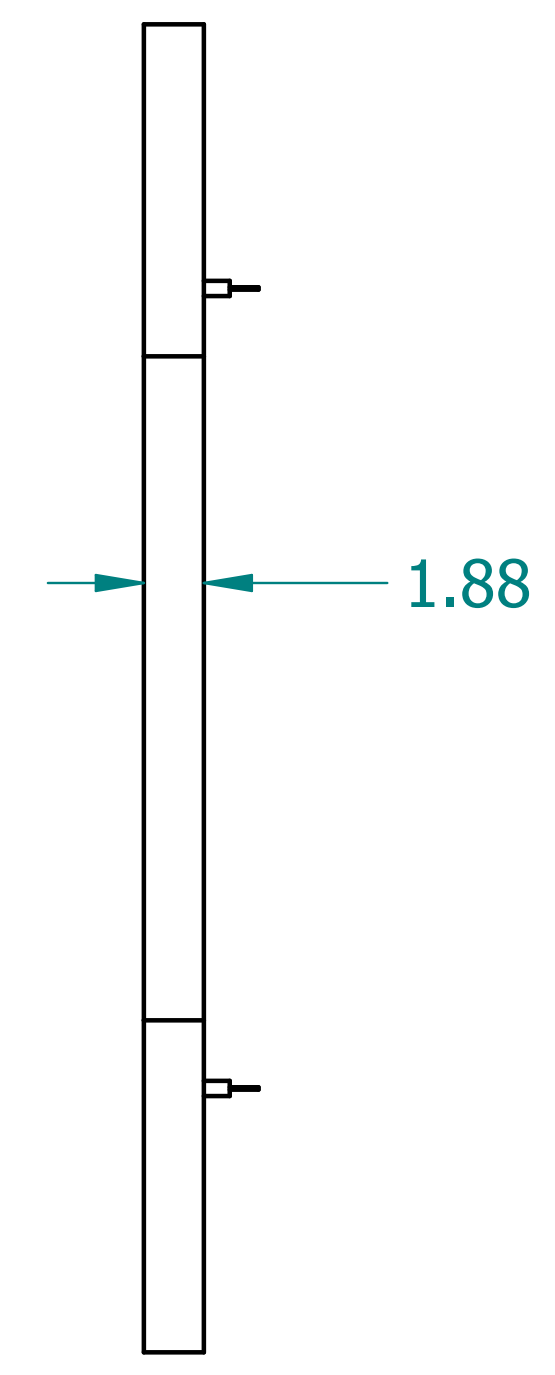

SECTION A-A

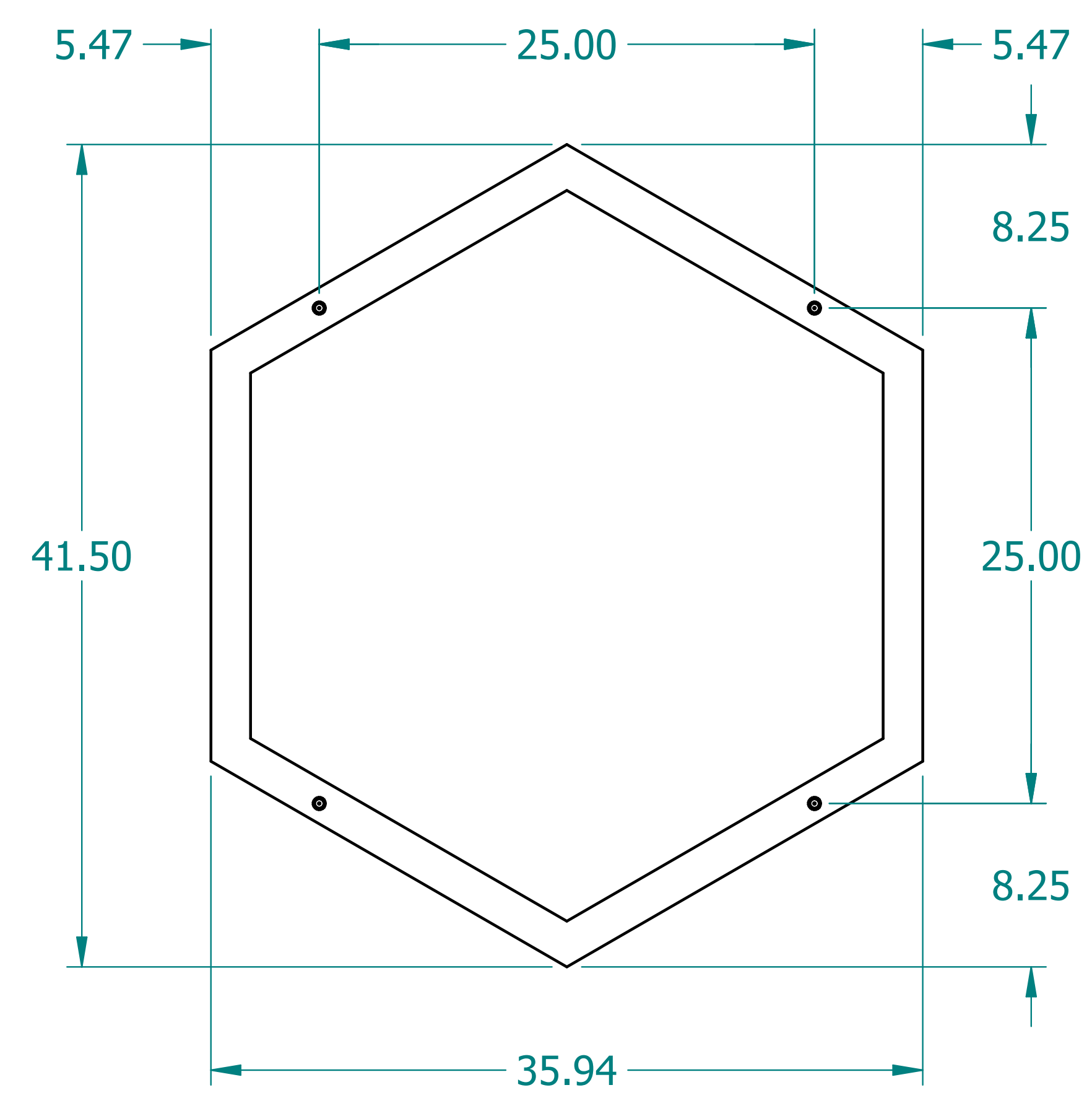
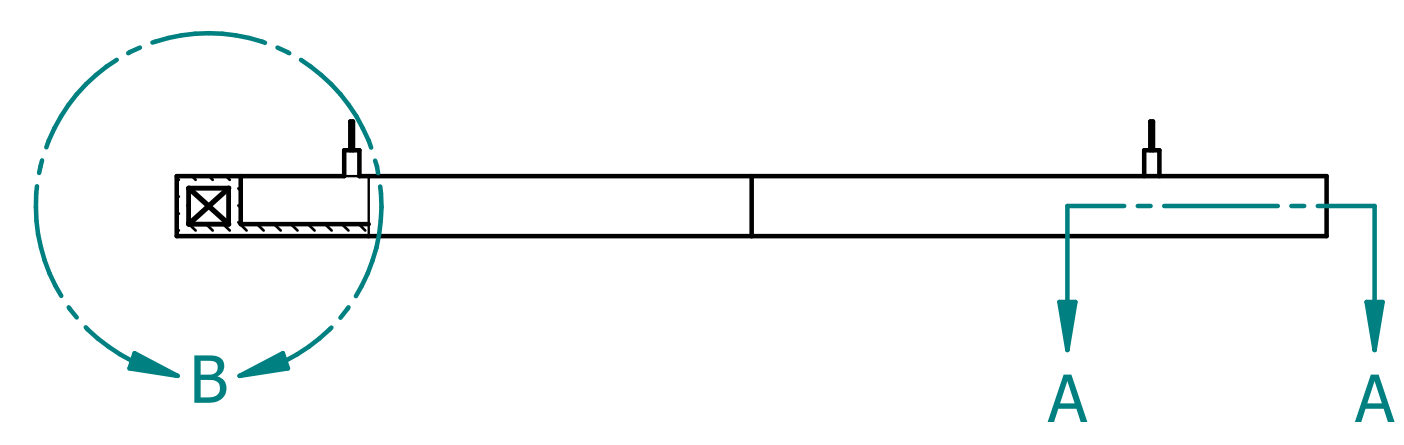
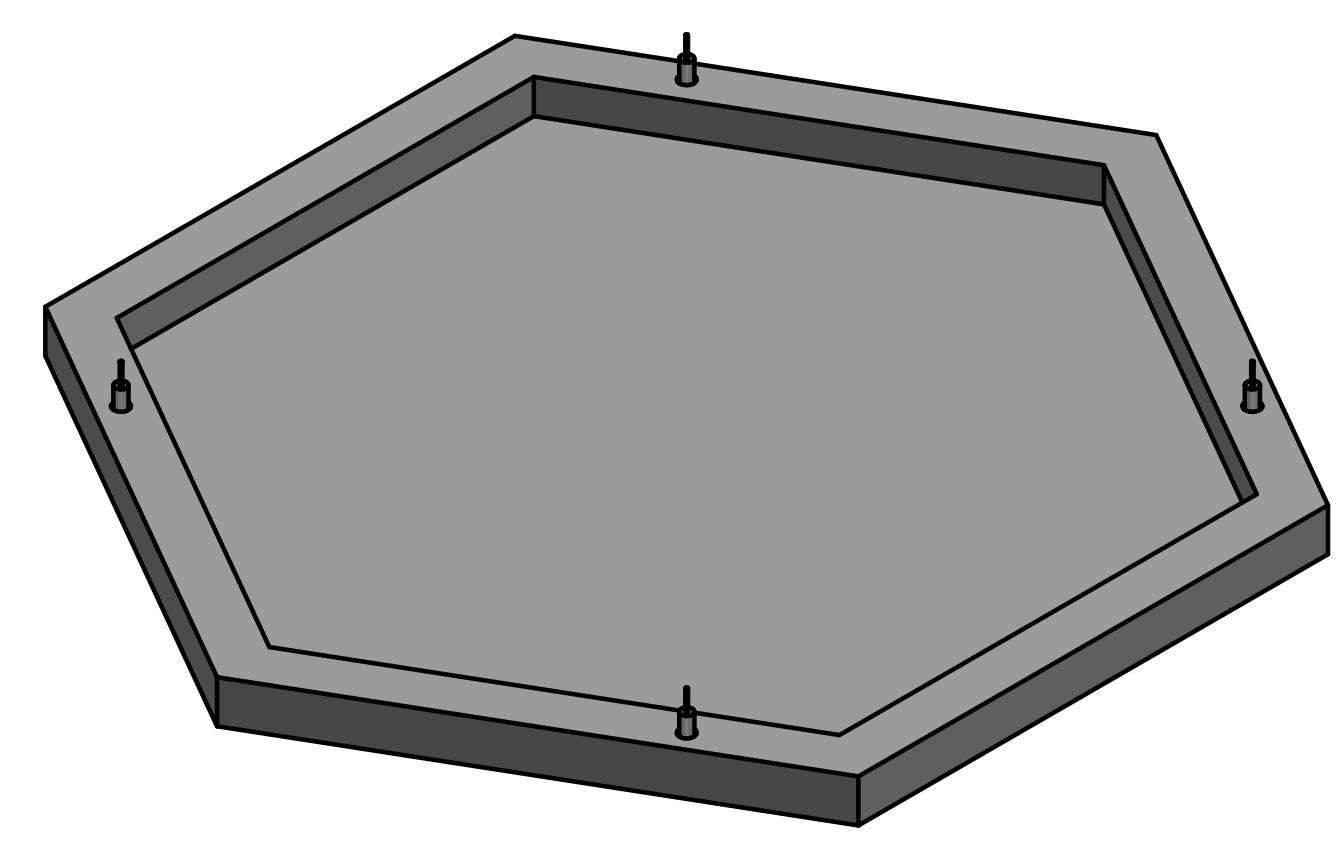
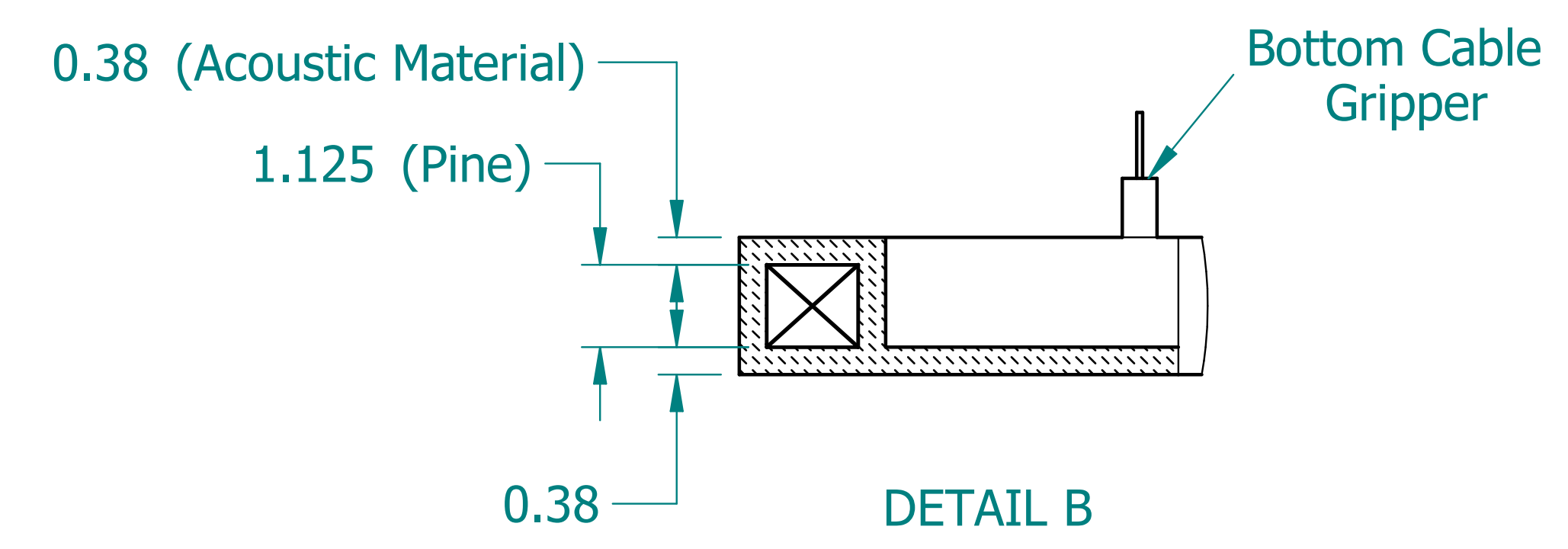
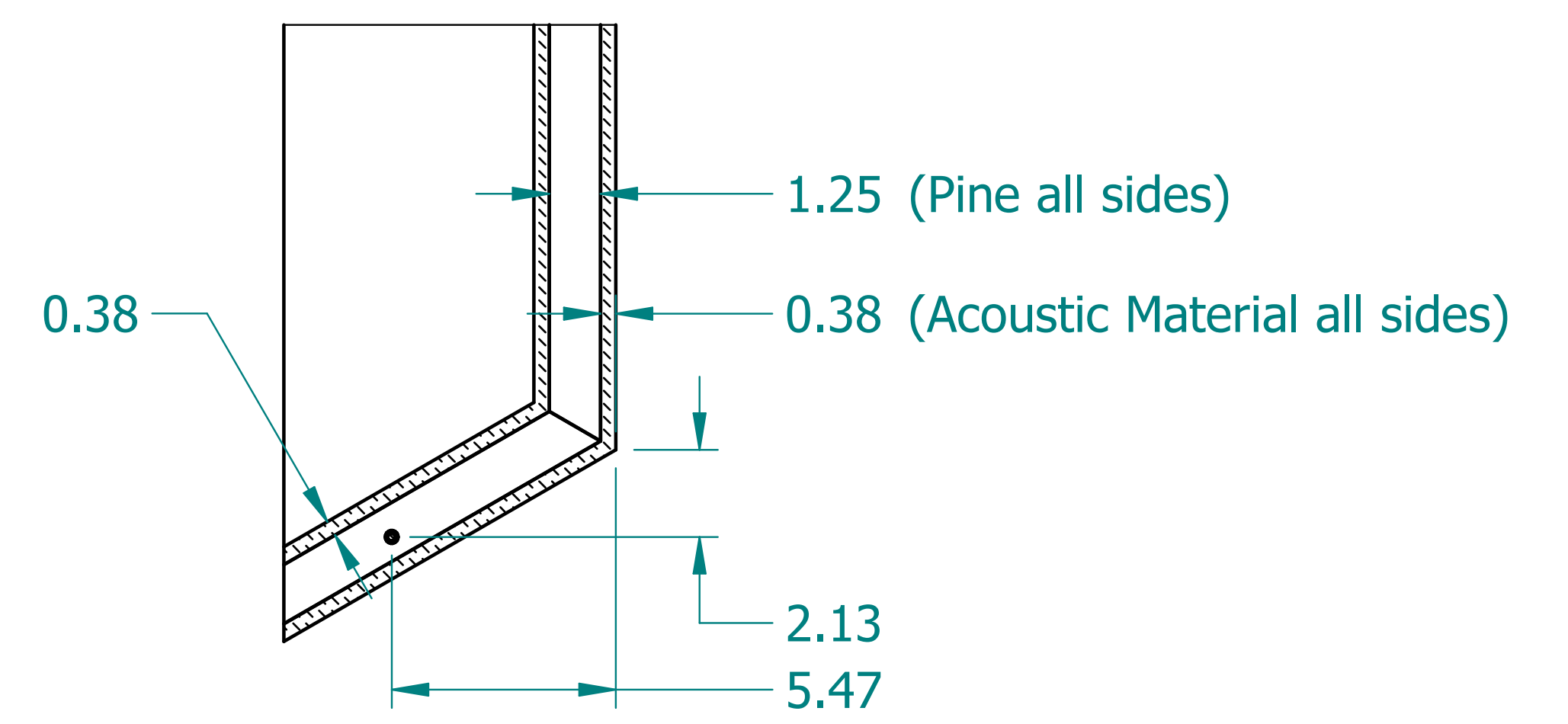

	NAME	DATE
DRAWN	SAI	04/29/20
ENG APPR	ERIC	04/29/20



UNLESS OTHERWISE SPECIFIED DIMENSIONS ARE IN 'INCHES'
 ANGLES $\pm 0.8^\circ$; 2 PL ± 0.040 ;
 3 PL ± 0.020

TITLE Acoustic Shape: Hexagon	
SUBTITLE 42"x42"x2"	
PART NO: AShape-3-04-XX	REV. 1.0
SIZE: 34"x22"	SCALE: 0.17
SHEET 1 OF 1	
FILE NAME: Acoustic Hexagon (42.42.2).dft	