

REVISION HISTORY

REV.	DESCRIPTION	DATE	APPROVED

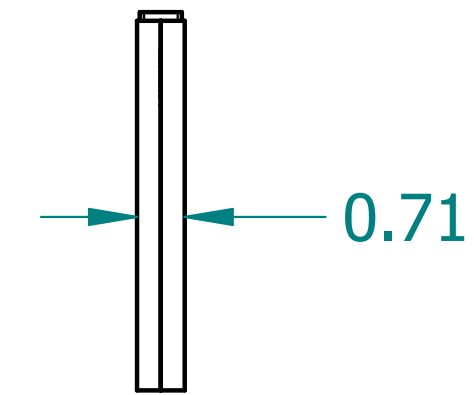

	NAME	DATE
DRAWN	CBS	01/05/24
ENG APPR	CBS	01/05/24

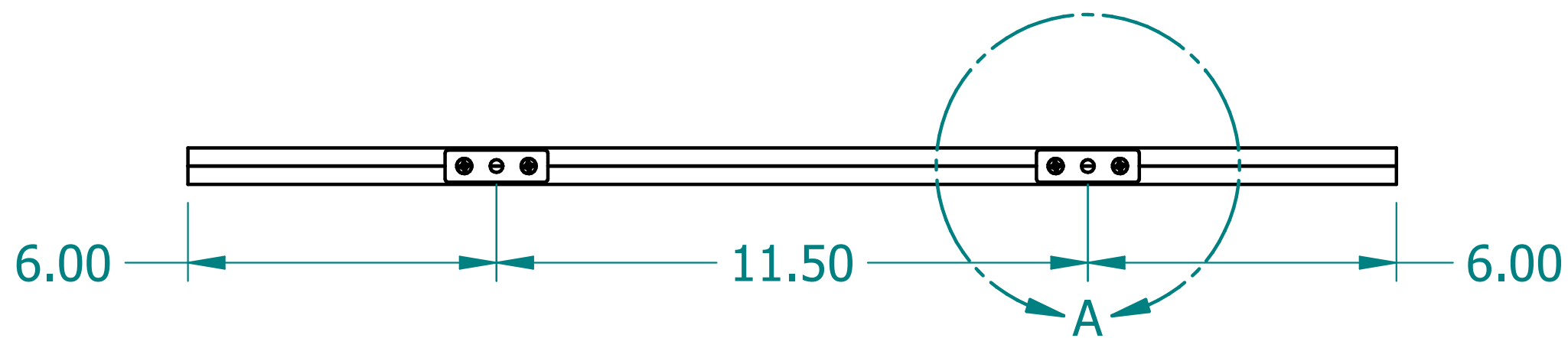
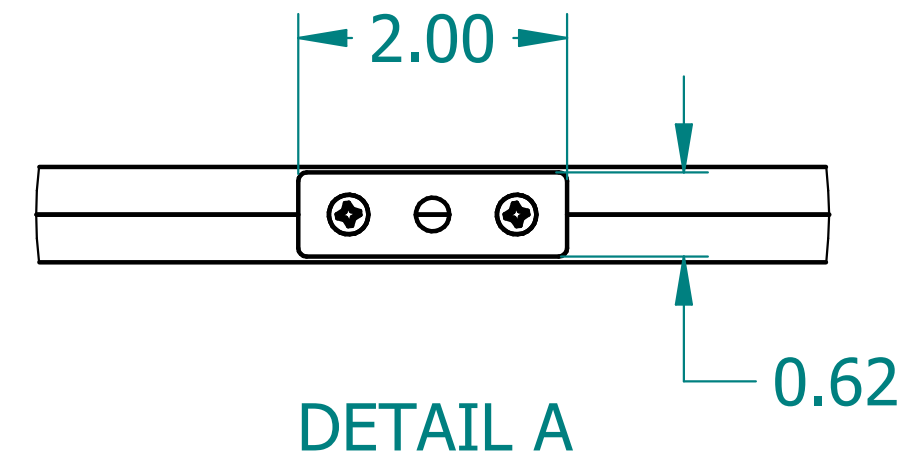
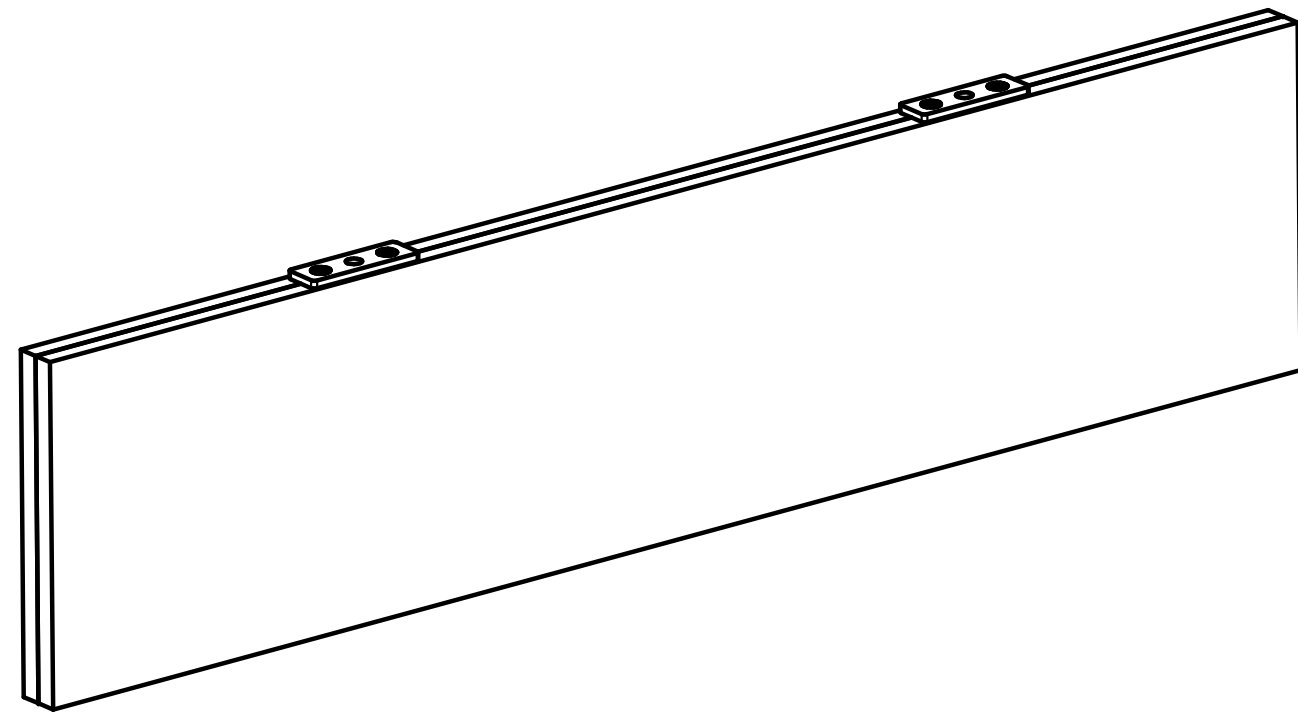
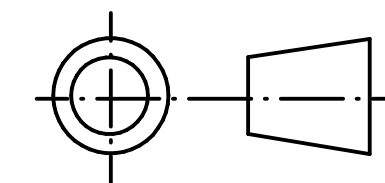

UNLESS OTHERWISE SPECIFIED DIMENSIONS ARE IN 'INCHES'
 ANGLES $\pm 0.8^\circ$; 2 PL ± 0.040 ;
 3 PL ± 0.020

TITLE Acoustic Fin		
SUBTITLE 24"x6"x18mm		
PART NO:	AFin-ST-001	REV. 0.0
SIZE: 22"x17"	SCALE: 0.20	SHEET 1 OF 1
FILE NAME: Acoustic Fin(24.6.18).dft		