

REVISION HISTORY			
REV.	DESCRIPTION	DATE	APPROVED

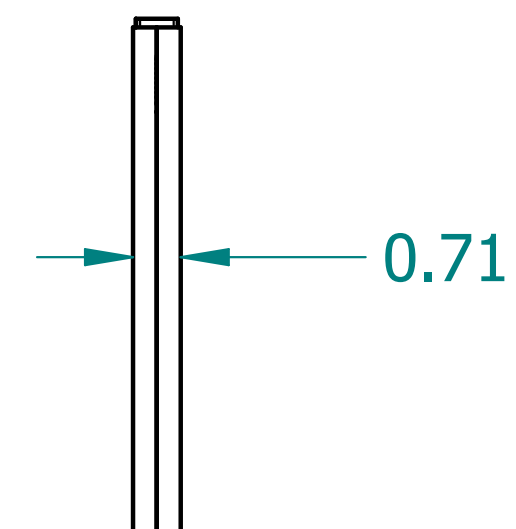

	NAME	DATE
DRAWN	CBS	01/09/24
ENG APPR	CBS	01/09/24

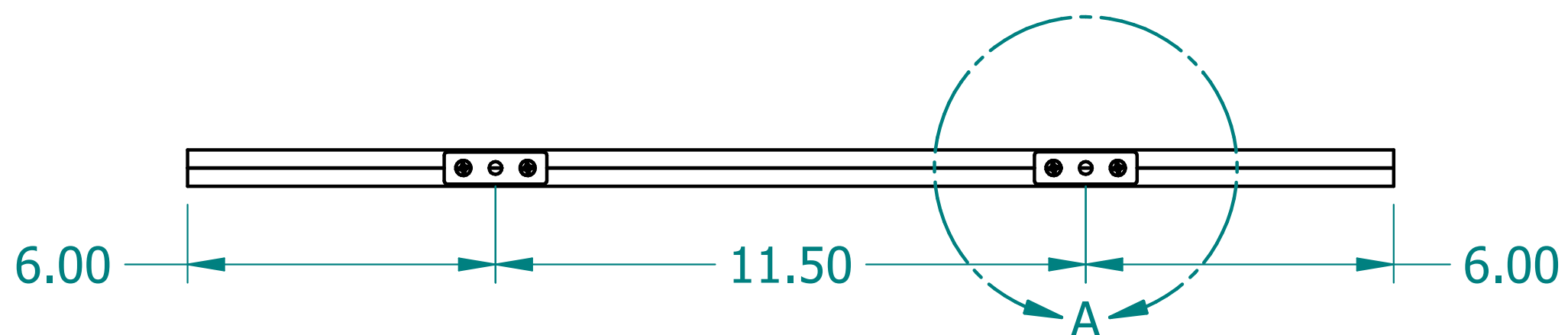
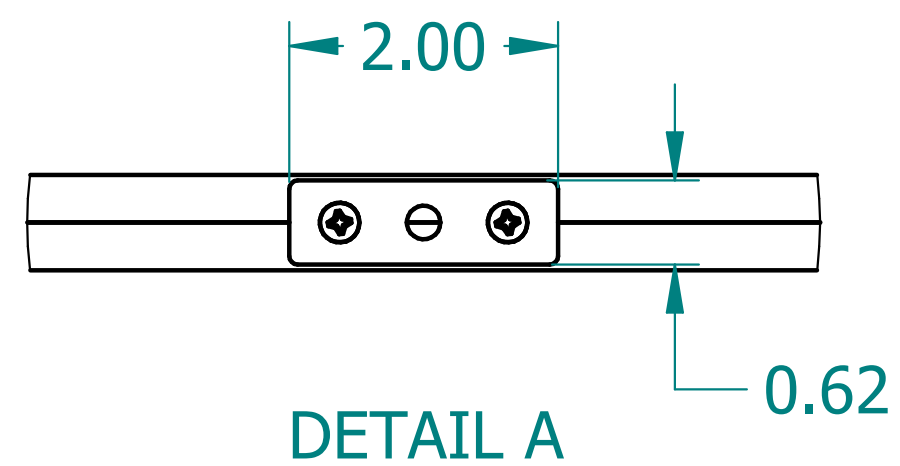
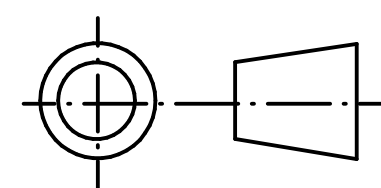

UNLESS OTHERWISE SPECIFIED
DIMENSIONS ARE IN
'INCHES'
ANGLES $\pm 0.8^\circ$; 2 PL ± 0.040 ;
3 PL ± 0.020

TITLE Acoustic Fin		
SUBTITLE 24"x8"x18mm		
PART NO:	AFin-ST-002	REV. 0.0
SIZE: 22"x17"	SCALE: 0.20	SHEET 1 OF 1
FILE NAME: Acoustic Fin(24.8.18).dft		