

REVISION HISTORY			
REV.	DESCRIPTION	DATE	APPROVED

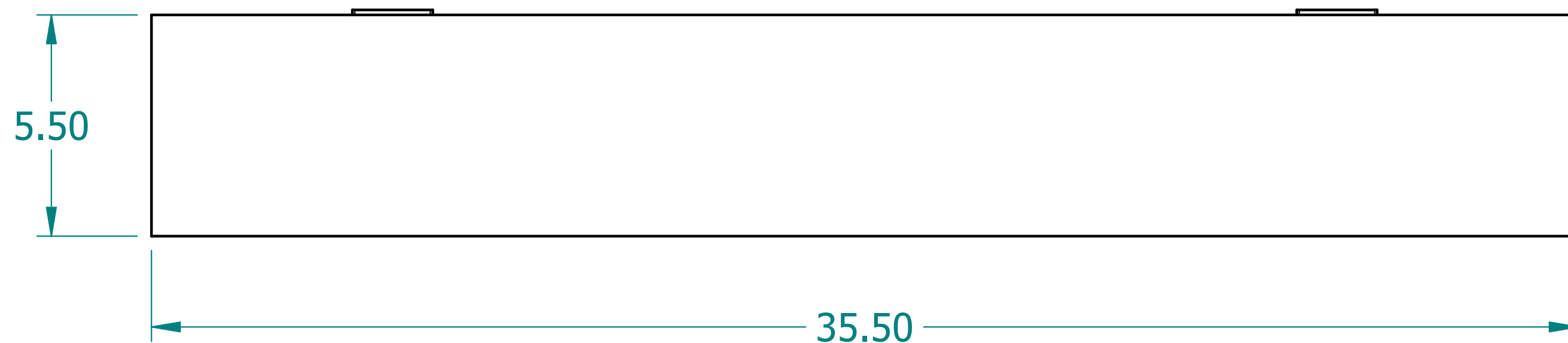

	NAME	DATE
DRAWN	CBS	01/09/24
ENG APPR	CBS	01/09/24

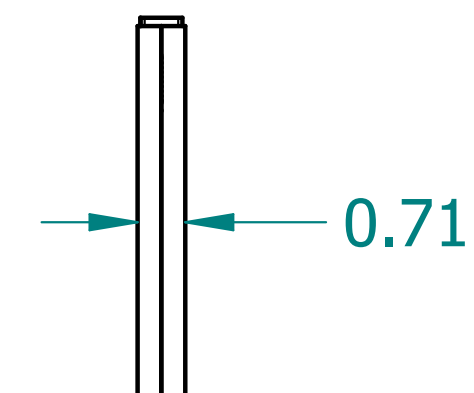
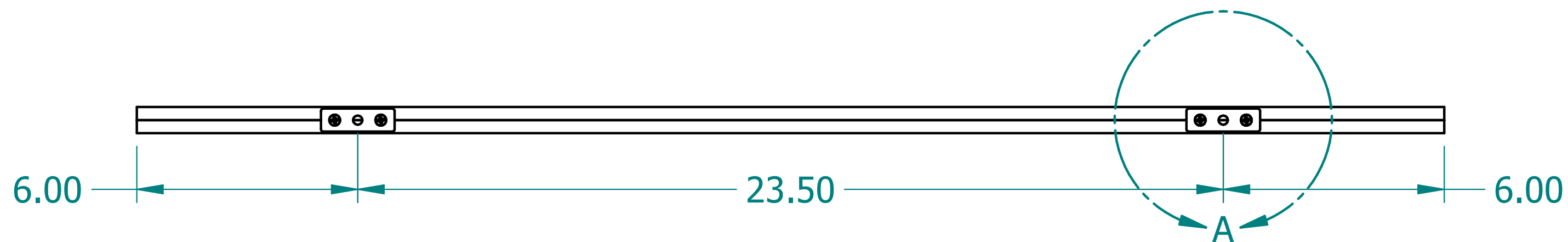
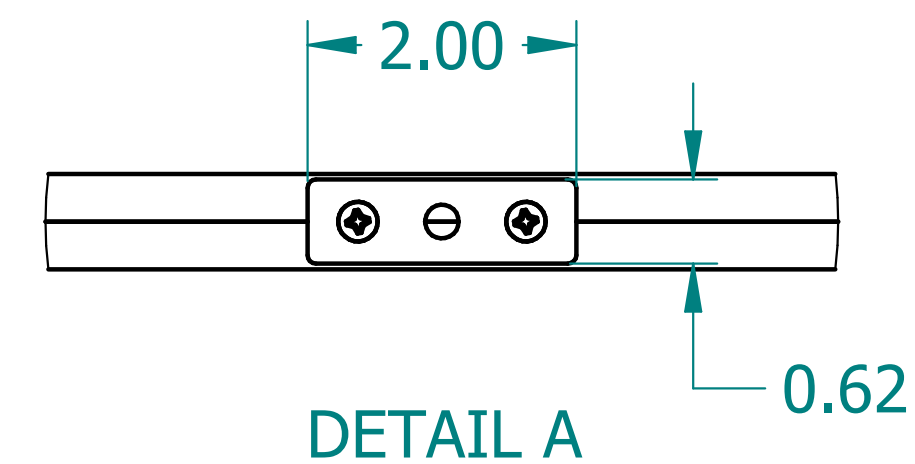
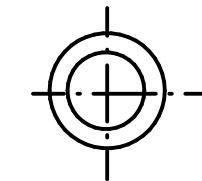
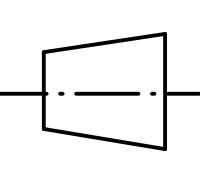

 UNLESS OTHERWISE SPECIFIED
 DIMENSIONS ARE IN
'INCHES'
 ANGLES $\pm 0.8^\circ$; 2 PL ± 0.040 ;
 3 PL ± 0.020

TITLE		Acoustic Fin	
SUBTITLE		36"x6"x18mm	
PART NO:	AFin-ST-005	REV.	0.0
SIZE: 22"x17"	SCALE: 0.20	SHEET 1 OF 1	
FILE NAME: Acoustic Fin(36.6.18).dft			