

REVISION HISTORY			
REV.	DESCRIPTION	DATE	APPROVED

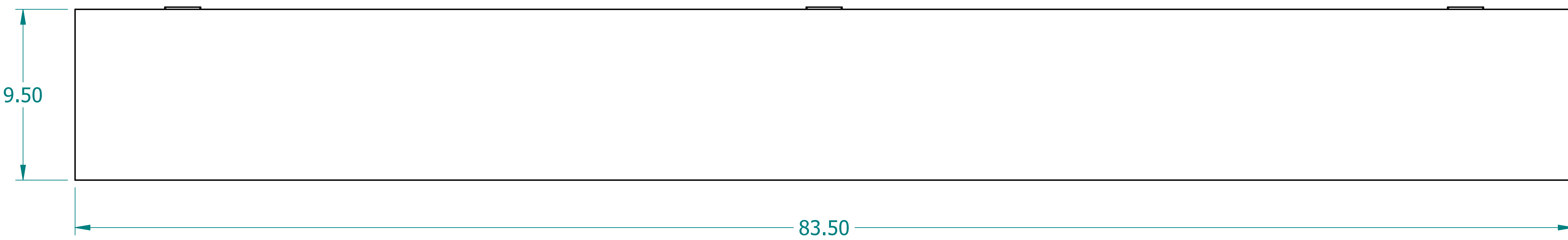

	NAME	DATE
DRAWN	CBS	01/29/24
ENG APPR	CBS	01/29/24

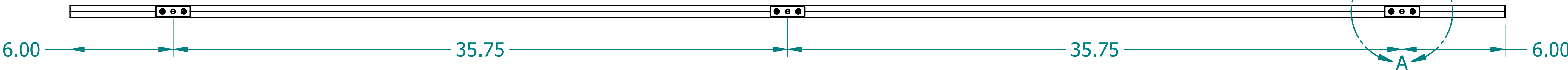
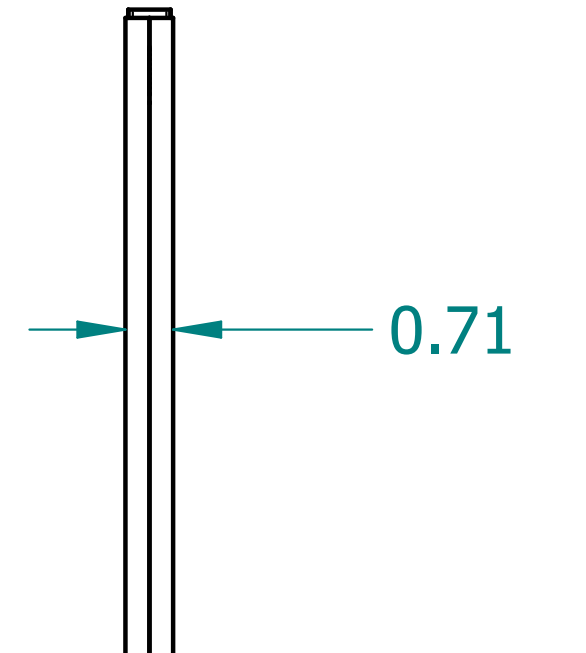
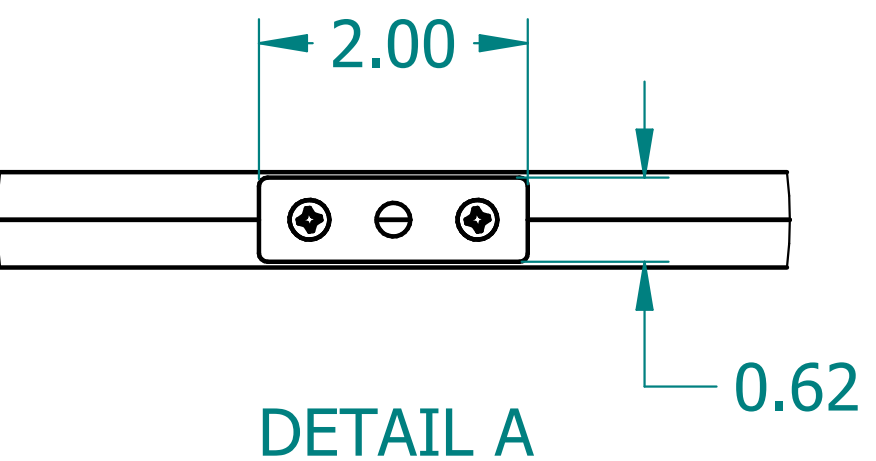
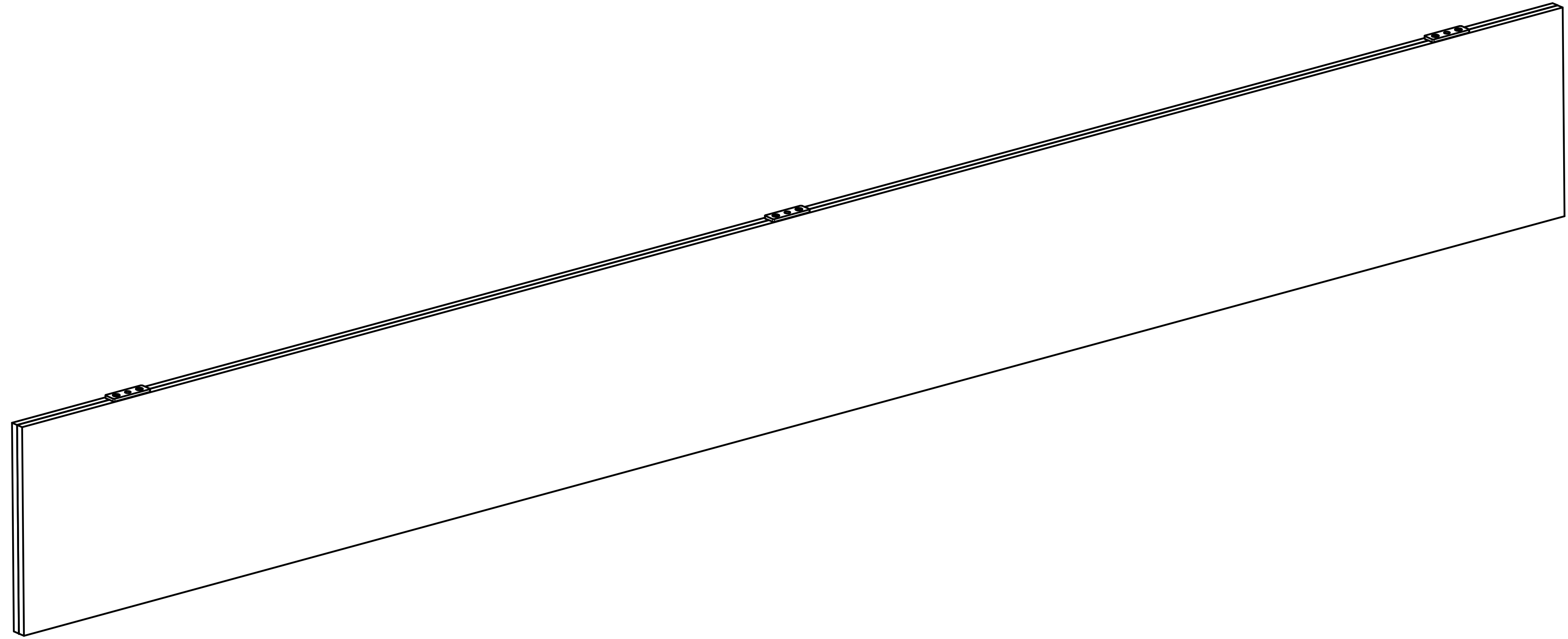

UNLESS OTHERWISE SPECIFIED DIMENSIONS ARE IN 'INCHES'
 ANGLES $\pm 0.8^\circ$; 2 PL ± 0.040 ;
 3 PL ± 0.020

TITLE Acoustic Fin	
SUBTITLE 84"x10"x18mm	
PART NO: AFin-ST-023	REV. 0.0
SIZE: 22"x17"	SCALE: 0.20
SHEET 1 OF 1	
FILE NAME: Acoustic Fin(84.10.18).dft	