

REVISION HISTORY			
REV.	DESCRIPTION	DATE	APPROVED

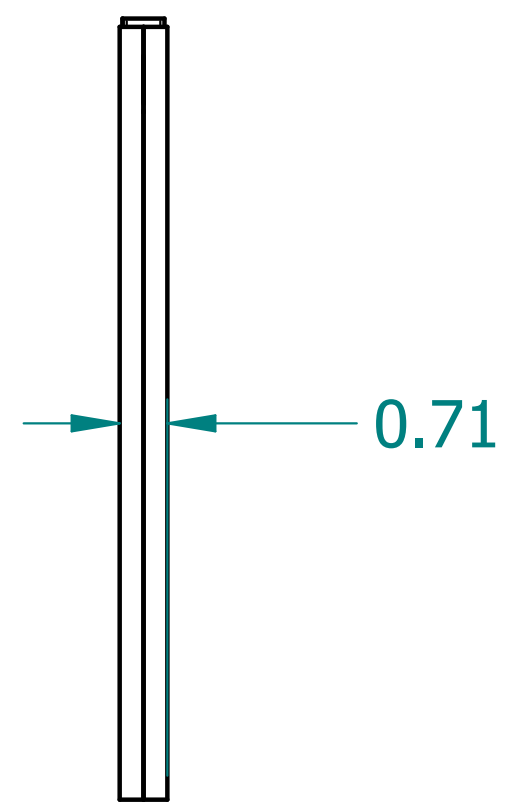

	NAME	DATE
DRAWN	CBS	01/29/24
ENG APPR	CBS	01/29/24

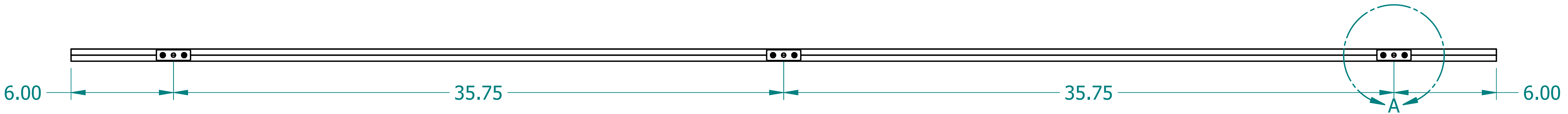

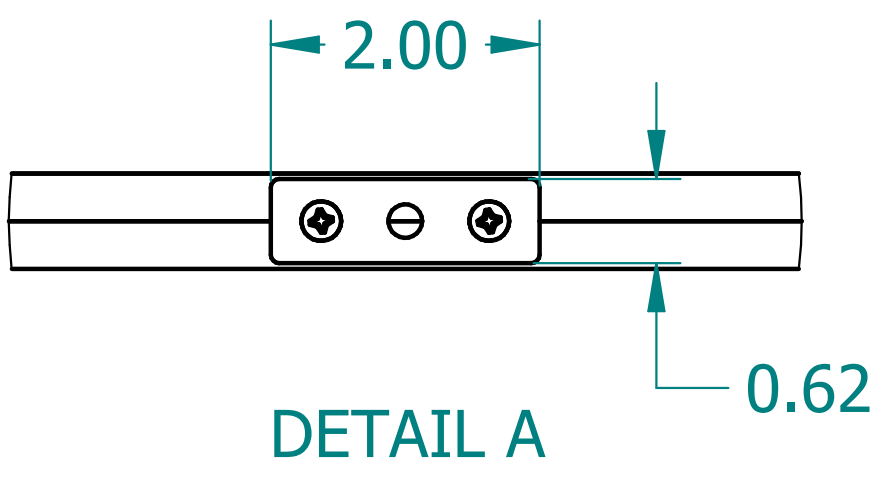
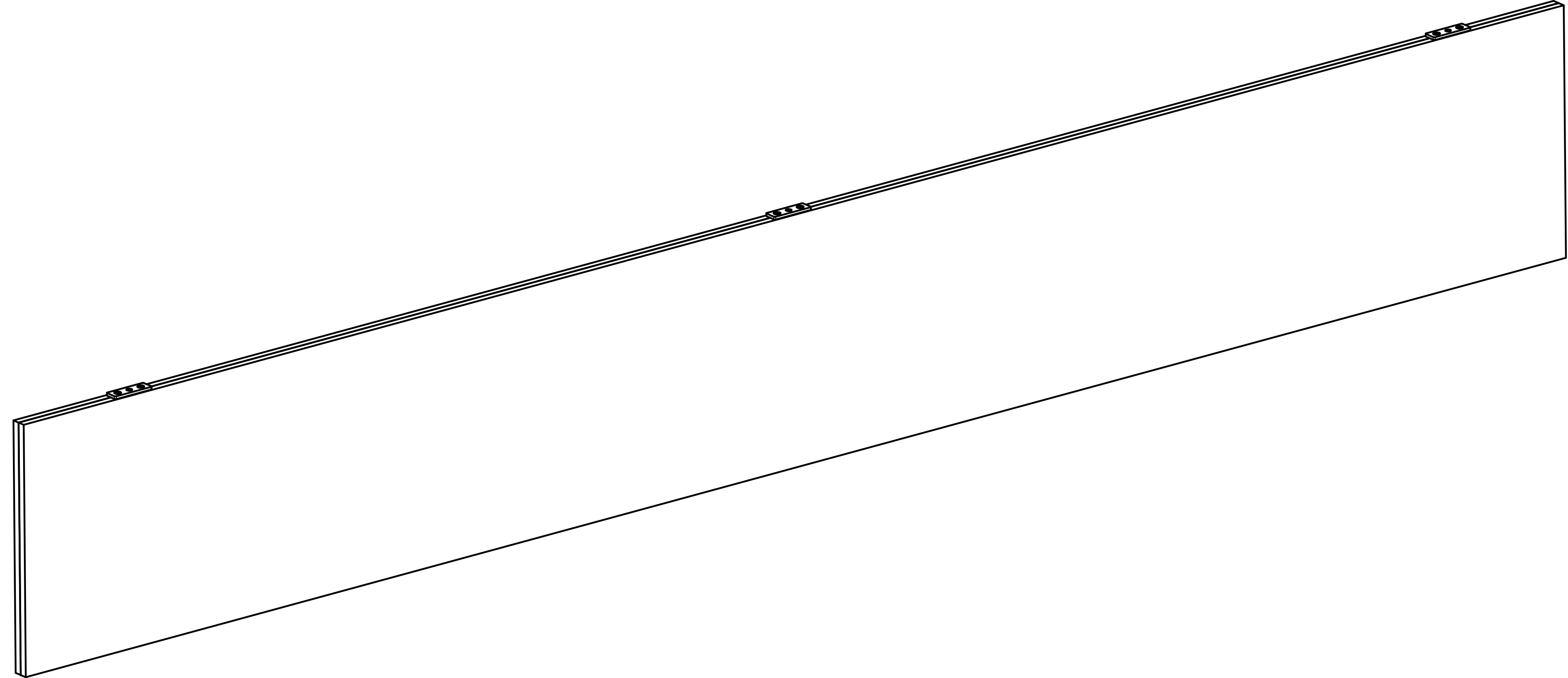
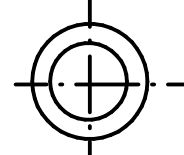
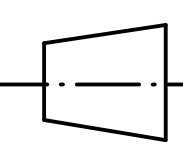

  
 UNLESS OTHERWISE SPECIFIED  
 DIMENSIONS ARE IN  
**'INCHES'**  
 ANGLES  $\pm 0.8^\circ$  ; 2 PL  $\pm 0.040$  ;  
 3 PL  $\pm 0.020$

TITLE		Acoustic Fin	
SUBTITLE		84"x12"x18mm	
PART NO:	AFin-ST-024	REV.	0.0
SIZE: 22"x17"	SCALE: 0.20	SHEET 1 OF 1	
FILE NAME: Acoustic Fin(84.12.18).dft			