

| REVISION HISTORY | | | |
|------------------|-------------|------|----------|
| REV. | DESCRIPTION | DATE | APPROVED |
| | | | |

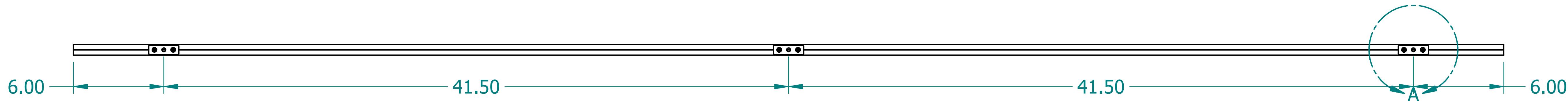

| | NAME | DATE |
|----------|------|----------|
| DRAWN | CBS | 02/05/24 |
| ENG APPR | CBS | 02/05/24 |

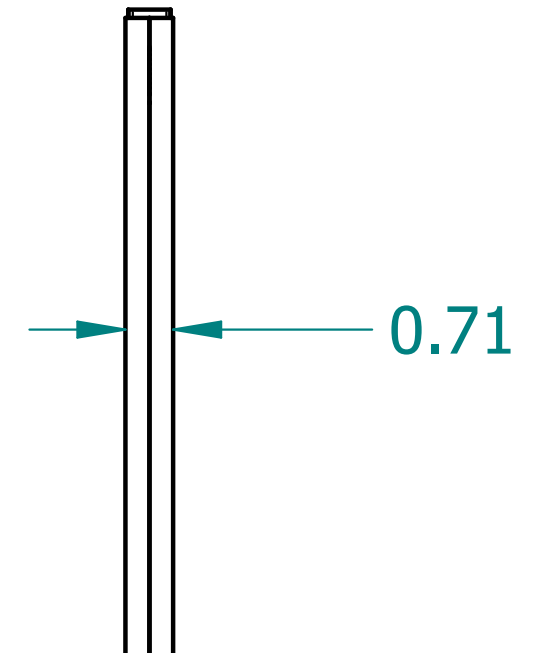
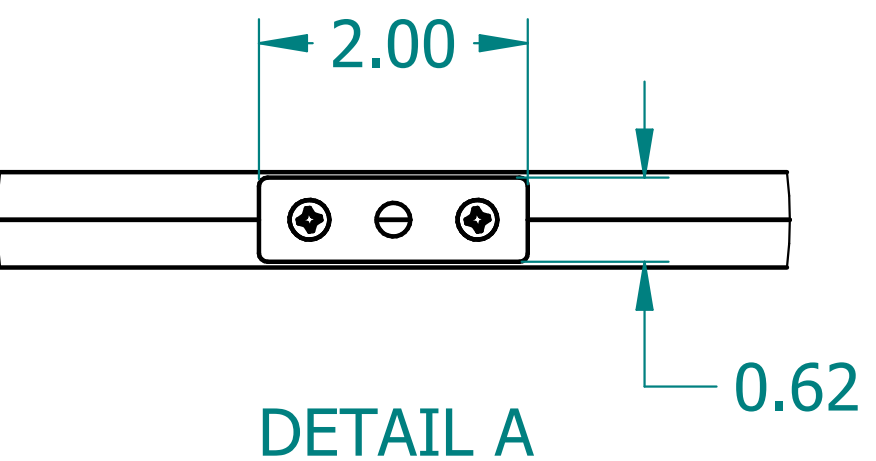
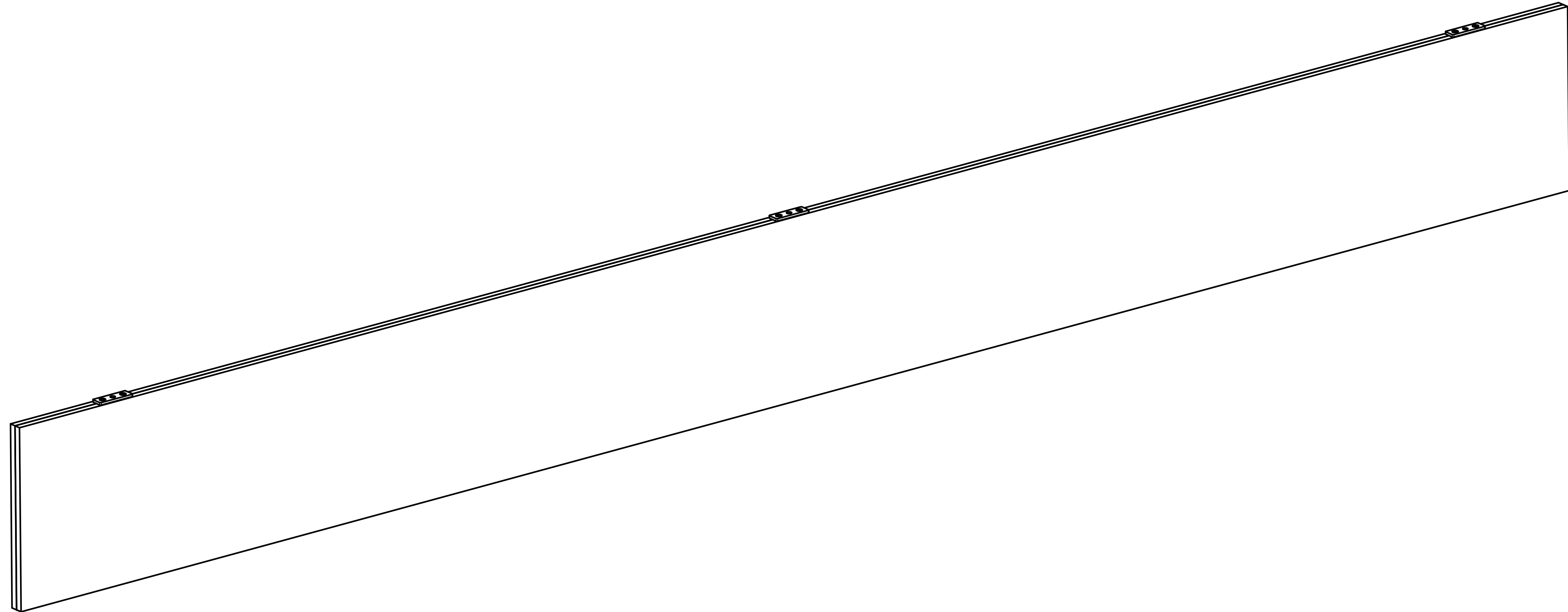

UNLESS OTHERWISE SPECIFIED DIMENSIONS ARE IN 'INCHES'
 ANGLES $\pm 0.8^\circ$; 2 PL ± 0.040 ;
 3 PL ± 0.020

| | | | |
|---------------------------------------|-------------|--------------|-----|
| TITLE | | Acoustic Fin | |
| SUBTITLE | | 96"x10"x18mm | |
| PART NO: | AFin-ST-027 | REV. | 0.0 |
| SIZE: 22"x17" | SCALE: 0.20 | SHEET 1 OF 1 | |
| FILE NAME: Acoustic Fin(96.10.18).dft | | | |