

REVISION HISTORY			
REV.	DESCRIPTION	DATE	APPROVED

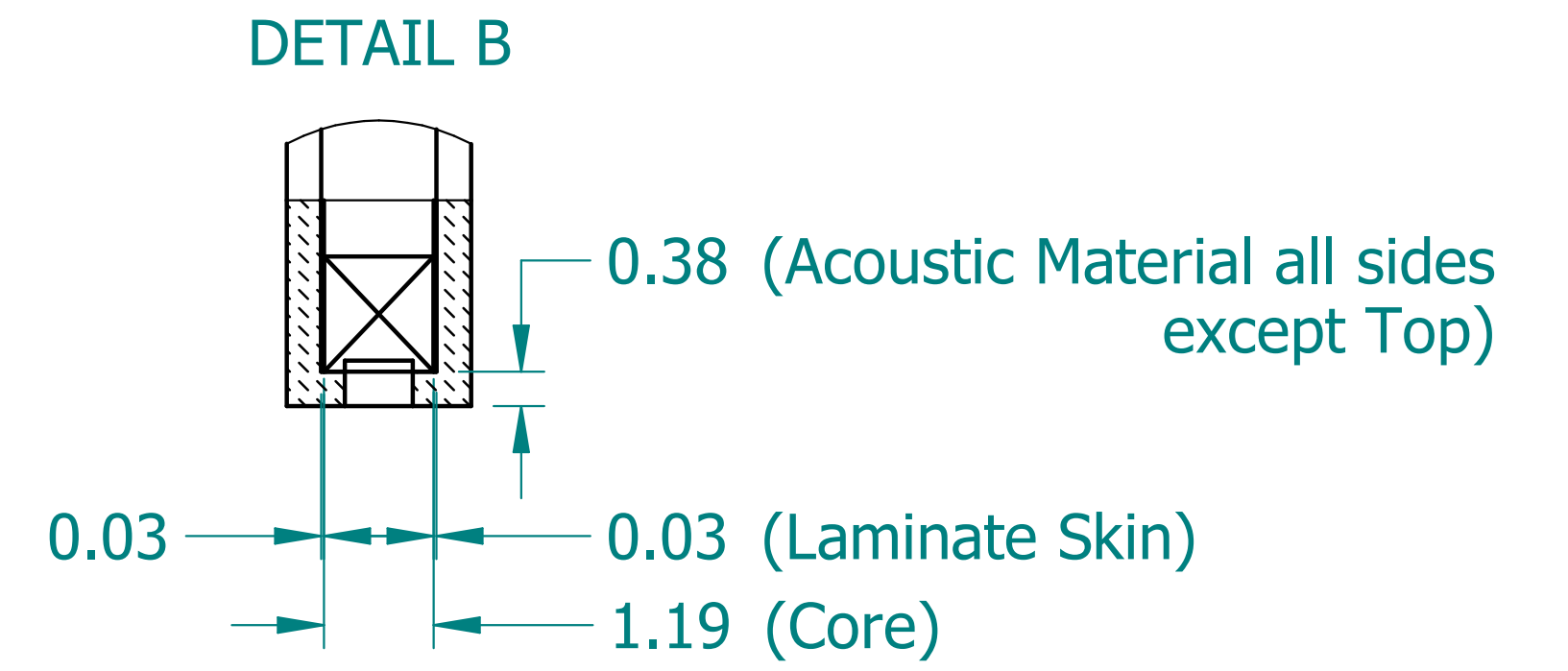

	NAME	DATE
DRAWN	CBS	11/29/23
ENG APPR	CBS	11/29/23

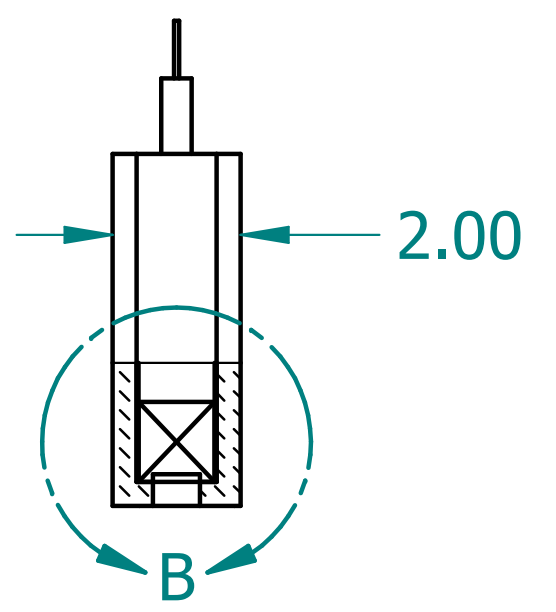
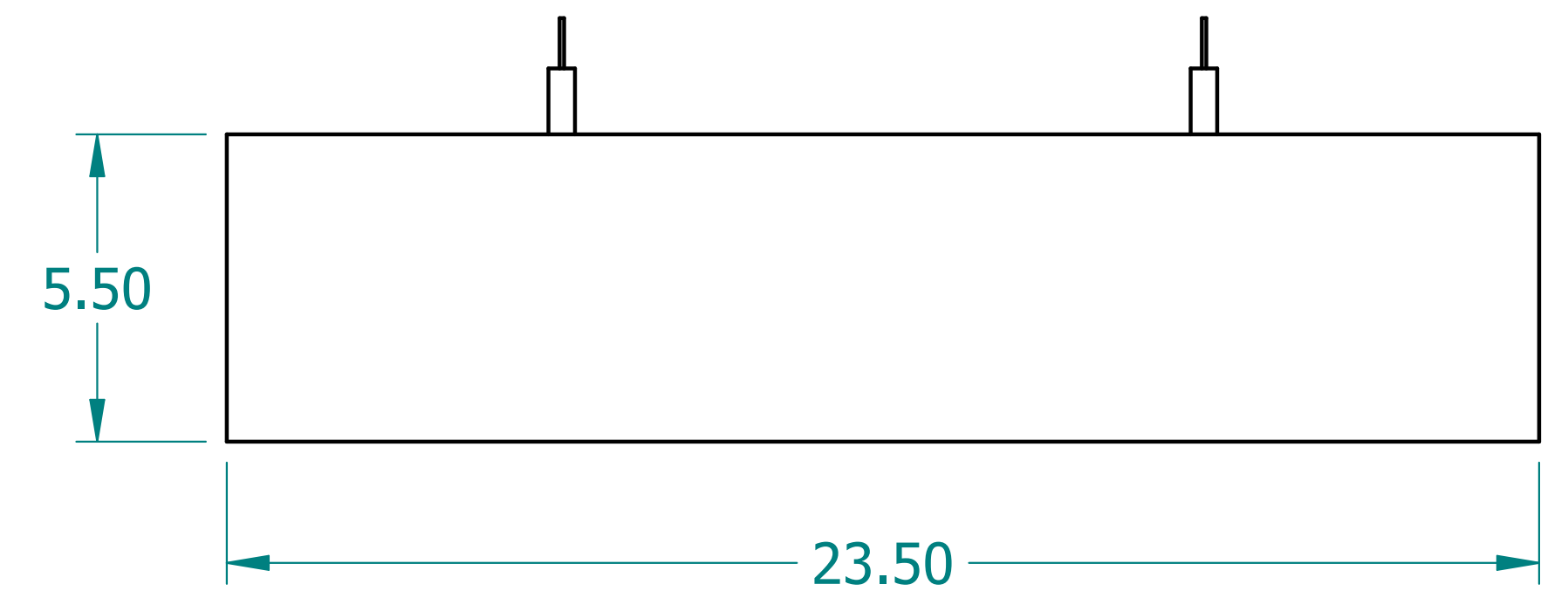
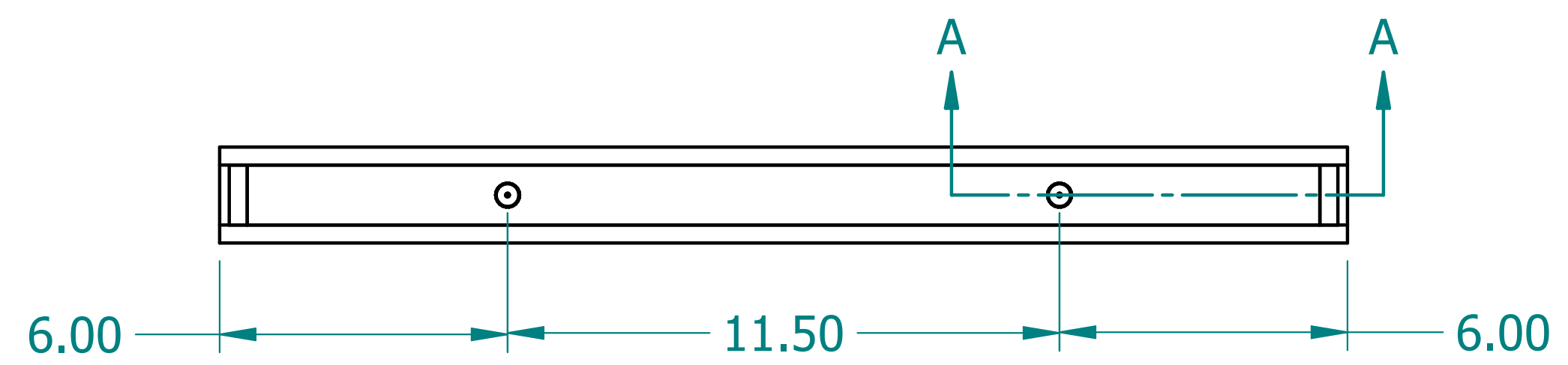
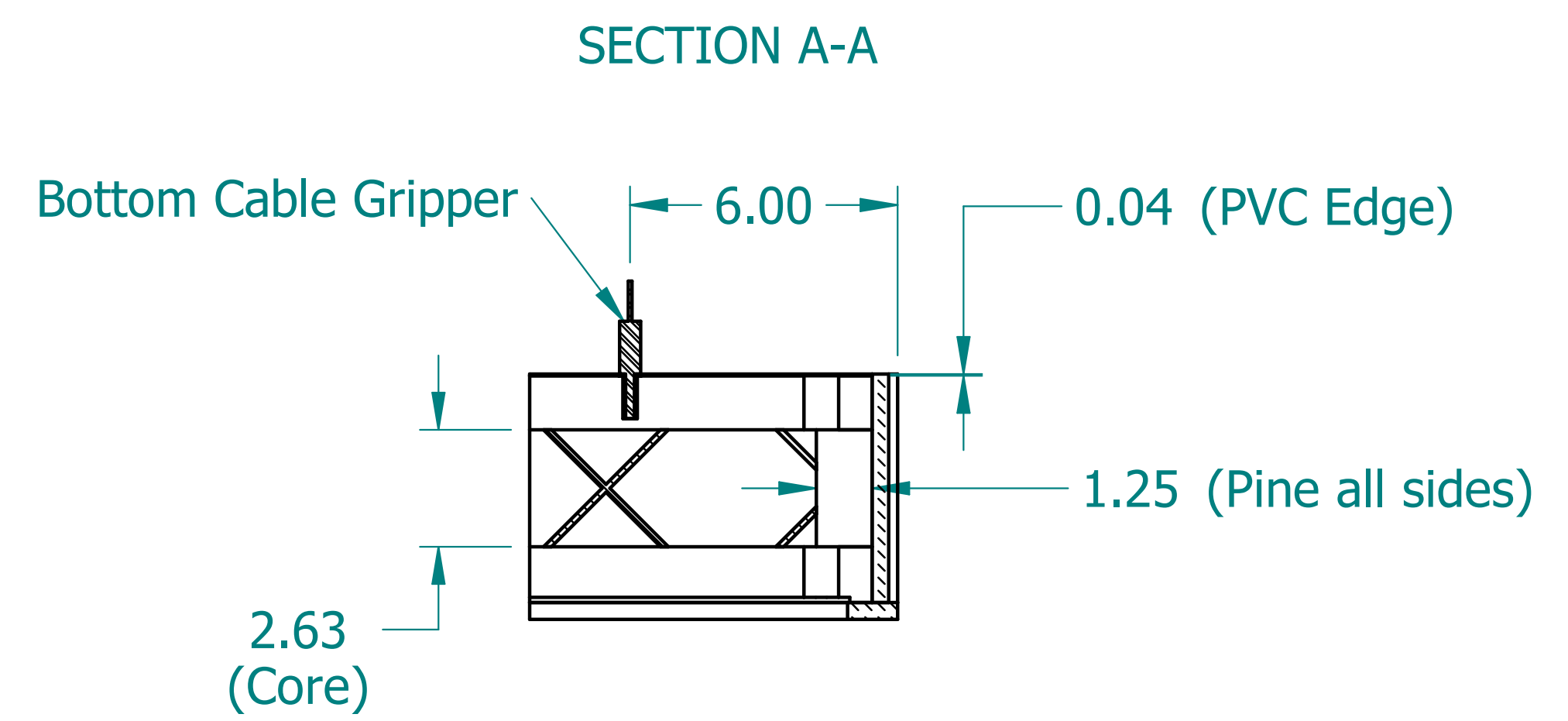
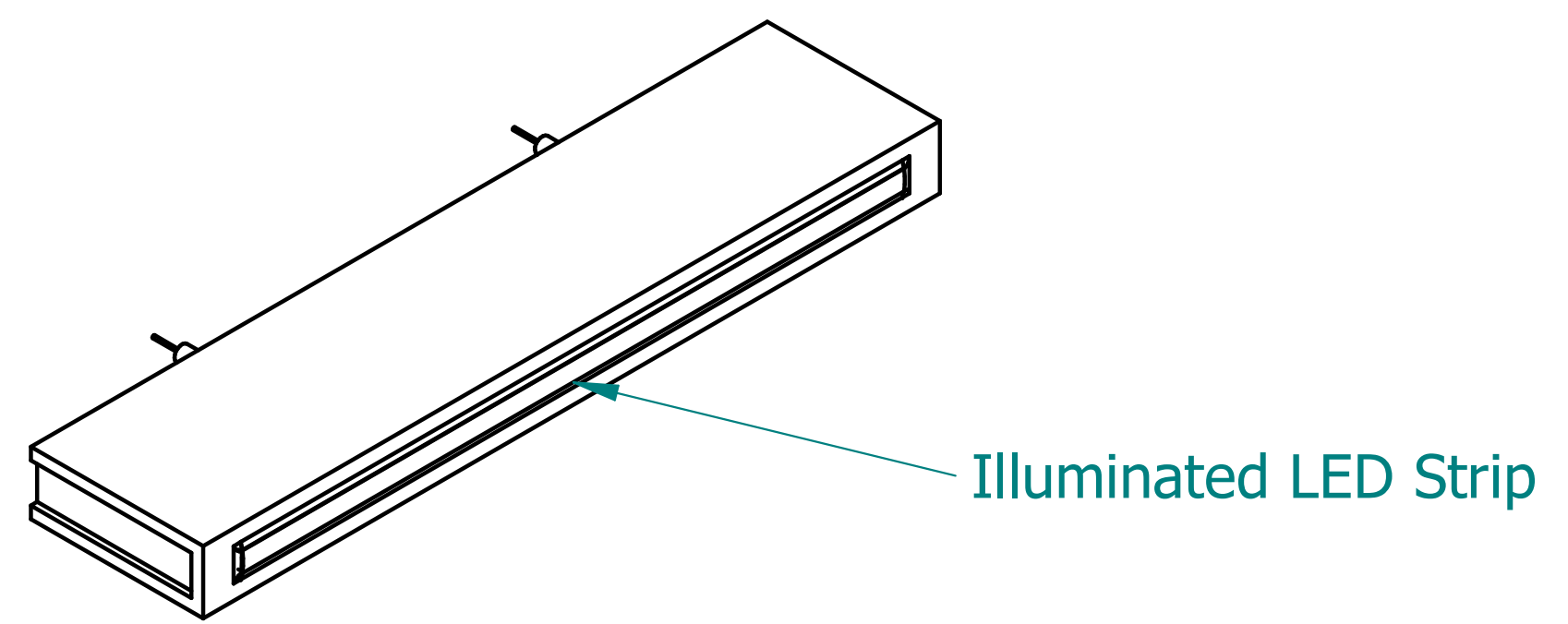

UNLESS OTHERWISE SPECIFIED DIMENSIONS ARE IN 'INCHES'
 ANGLES $\pm 0.8^\circ$; 2 PL ± 0.040 ;
 3 PL ± 0.020

TITLE Illuminated Acoustic Blade		
SUBTITLE 24"x6"x2"		
PART NO: IXABlade-005-XX	REV. 1.0	
SIZE: 34"x22"	SCALE: 0.33	SHEET 1 OF 1
FILE NAME: Illuminated Acoustic Blade (24.6.2).dft		