

REVISION HISTORY			
REV.	DESCRIPTION	DATE	APPROVED

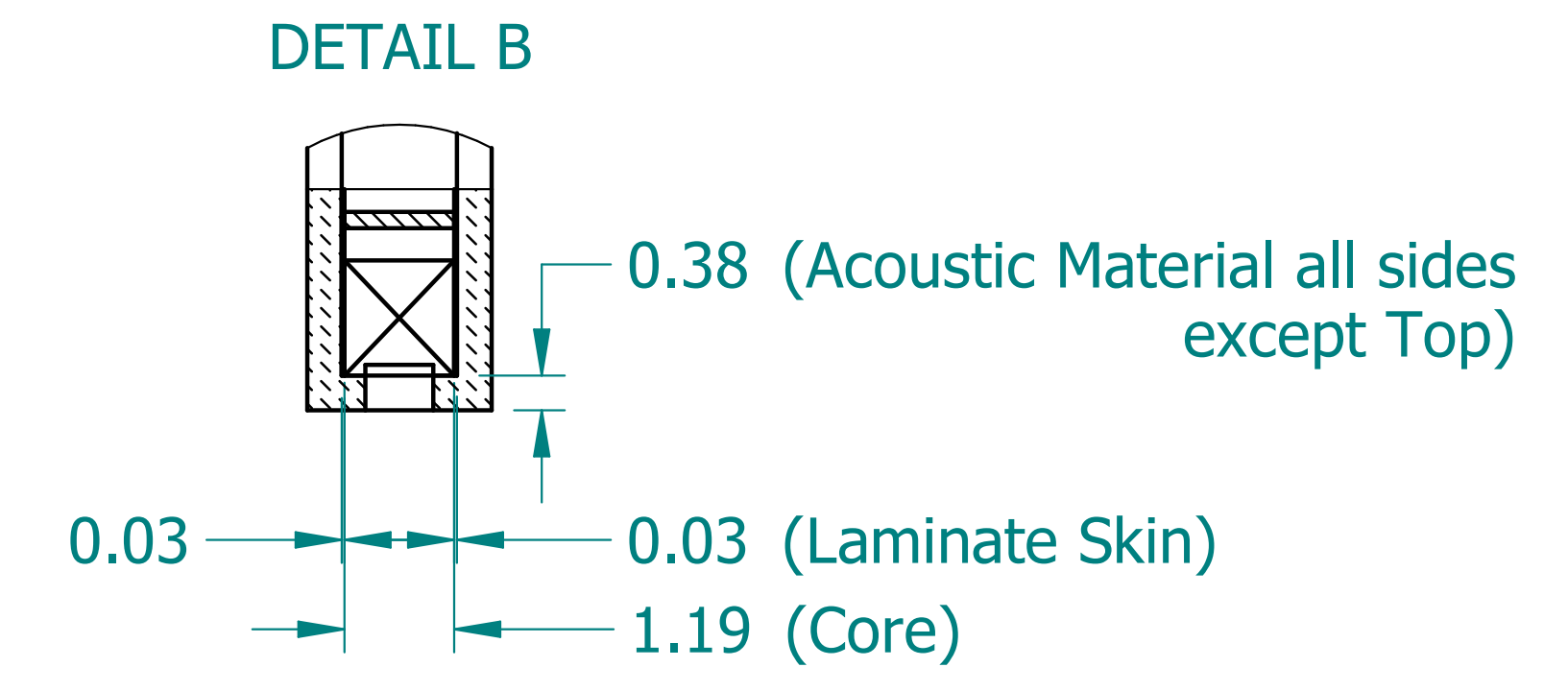

	NAME	DATE
DRAWN	CBS	11/16/23
ENG APPR	CBS	11/16/23

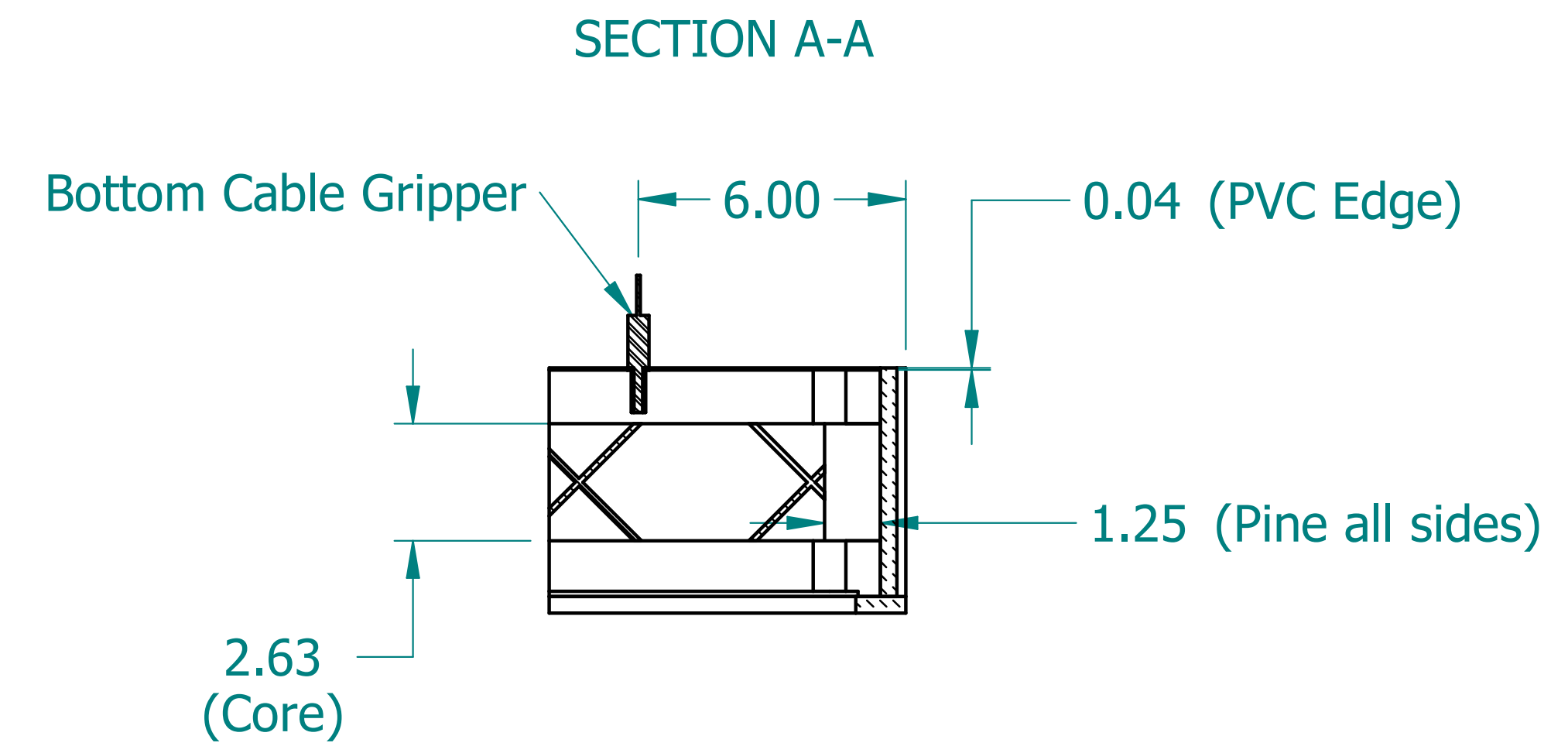
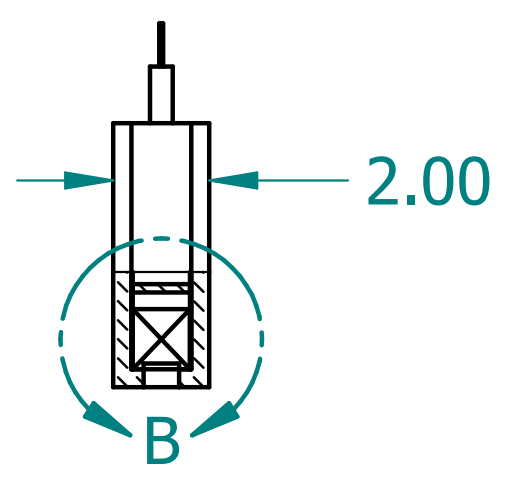
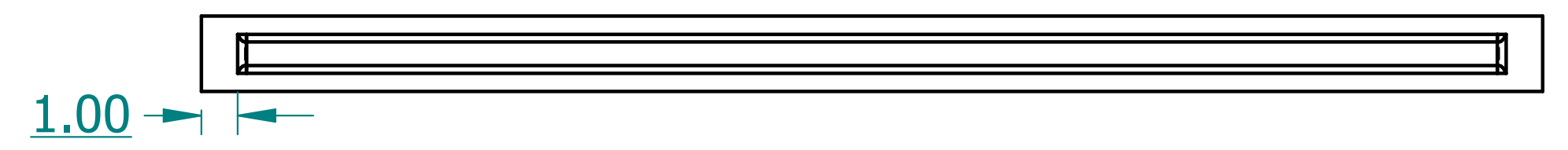
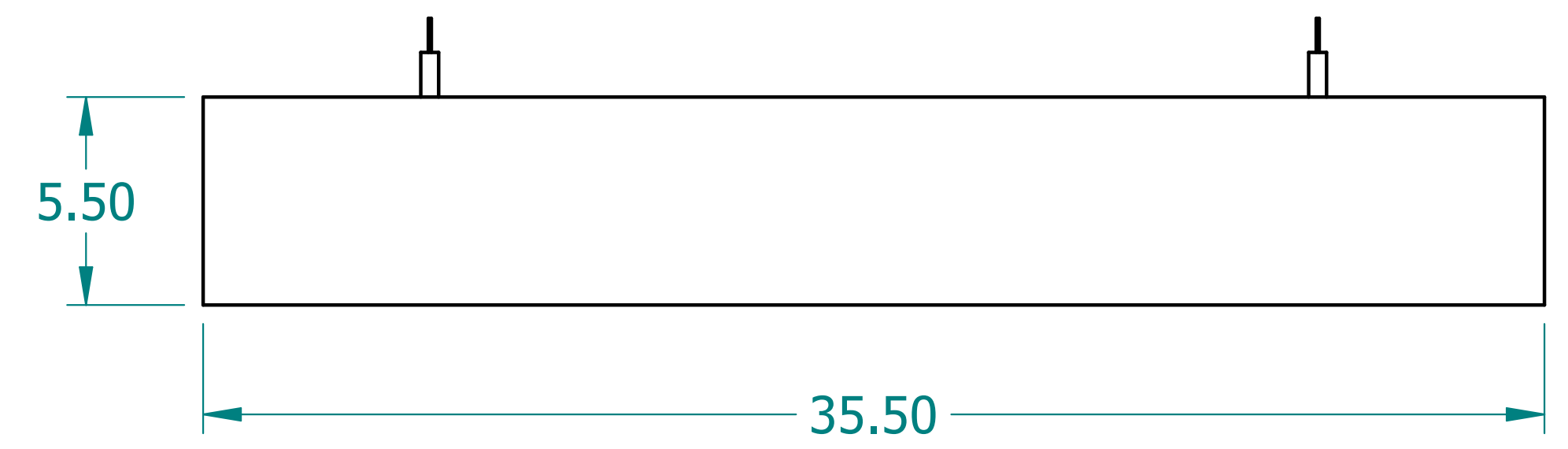
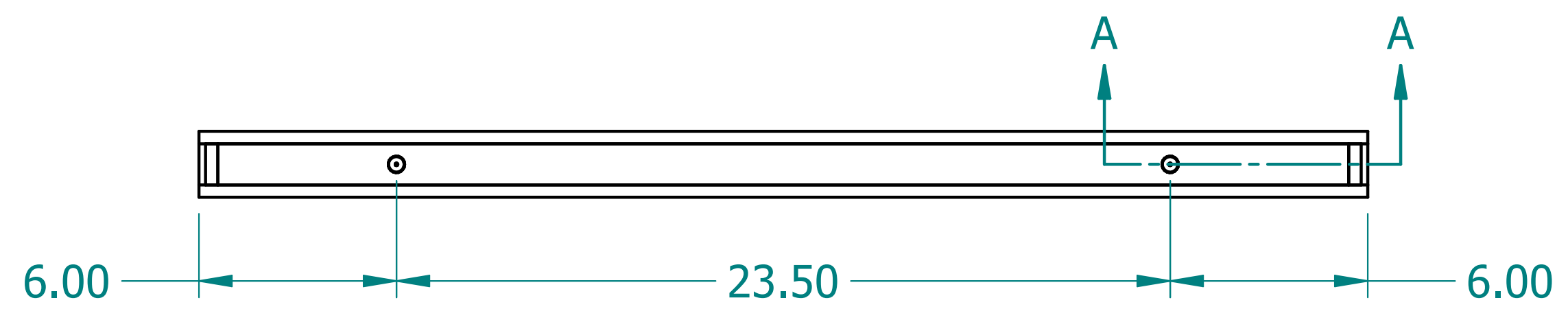
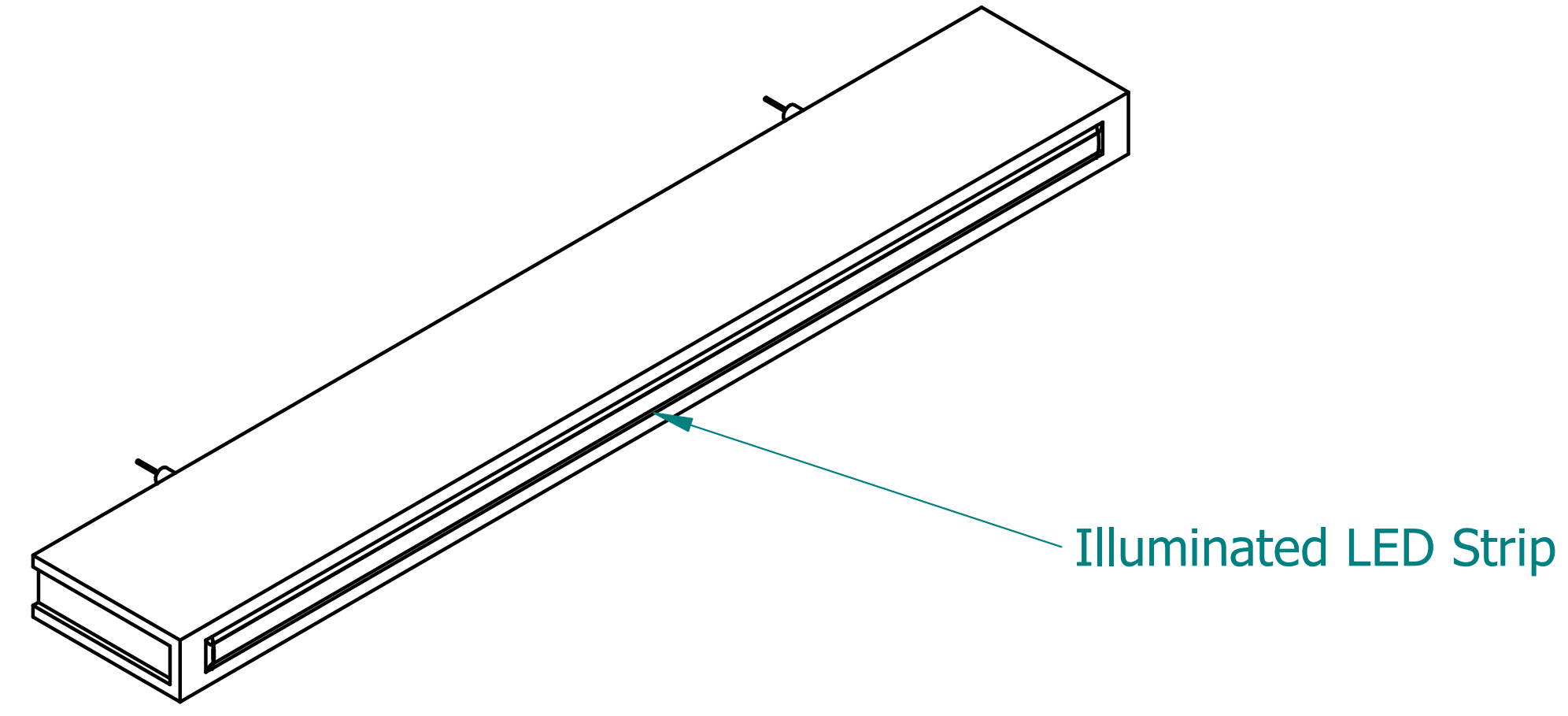

UNLESS OTHERWISE SPECIFIED DIMENSIONS ARE IN 'INCHES'
 ANGLES $\pm 0.8^\circ$; 2 PL ± 0.040 ;
 3 PL ± 0.020

TITLE Illuminated Acoustic Blade		
SUBTITLE 36"x6"x2"		
PART NO:	IXABlade-013-XX	REV. 1.0
SIZE: 34"x22"	SCALE: 0.25	SHEET 1 OF 1
FILE NAME: Illuminated Acoustic Blade (36.6.2).dft		