

REVISION HISTORY			
REV.	DESCRIPTION	DATE	APPROVED

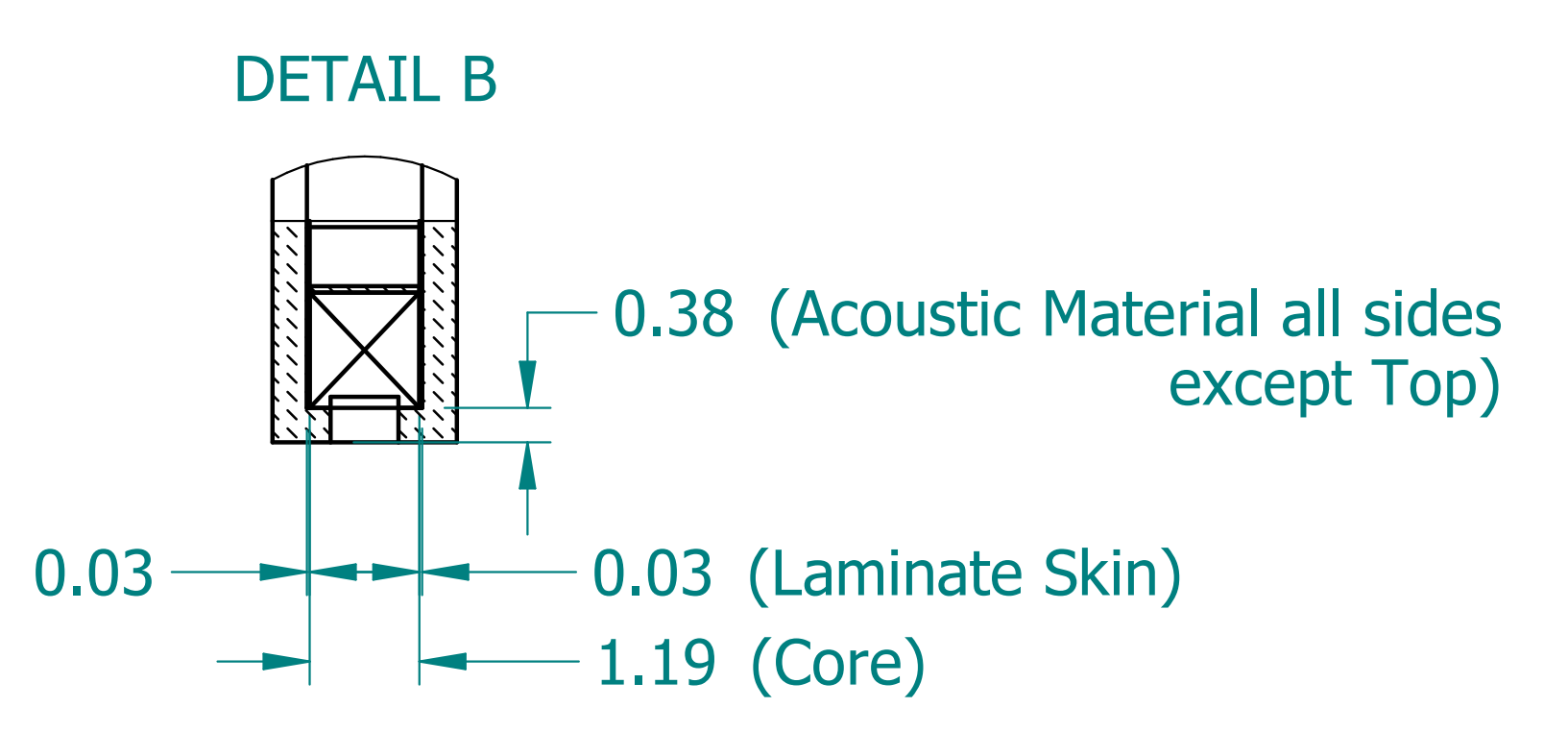

	NAME	DATE
DRAWN	CBS	11/16/23
ENG APPR	CBS	11/16/23

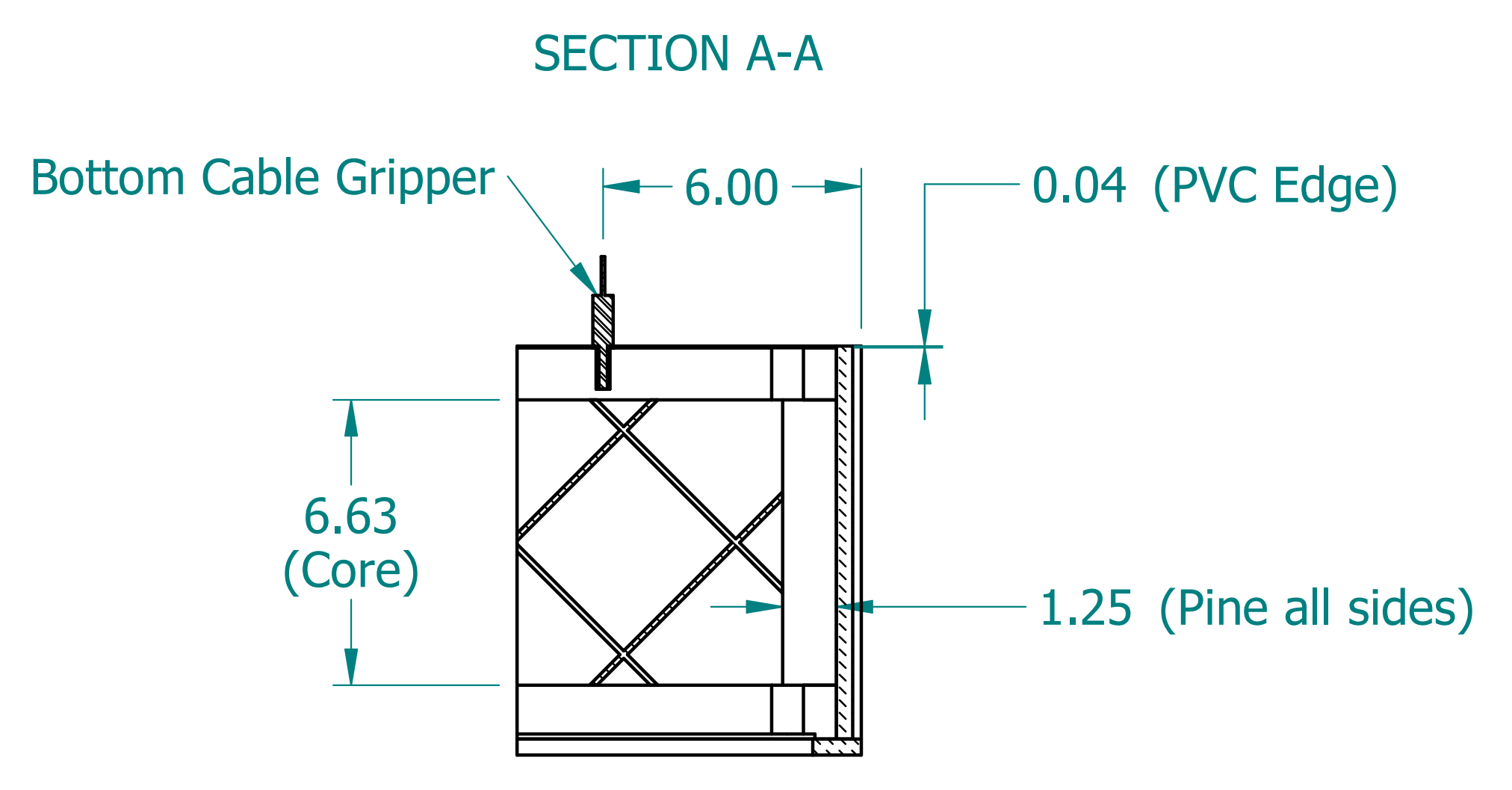
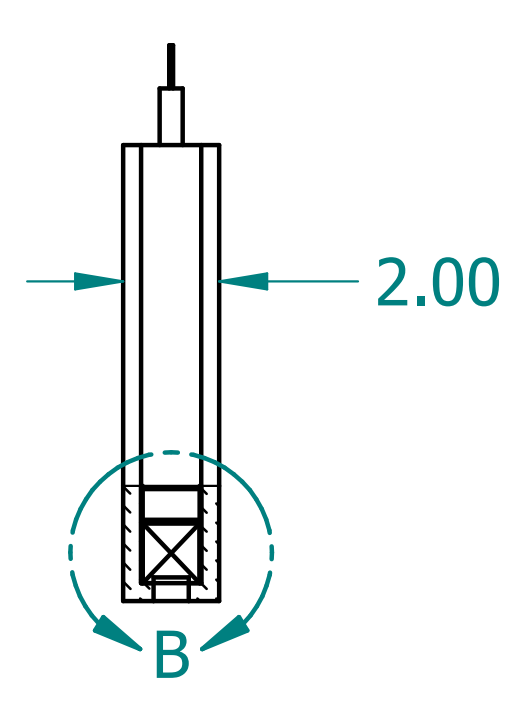
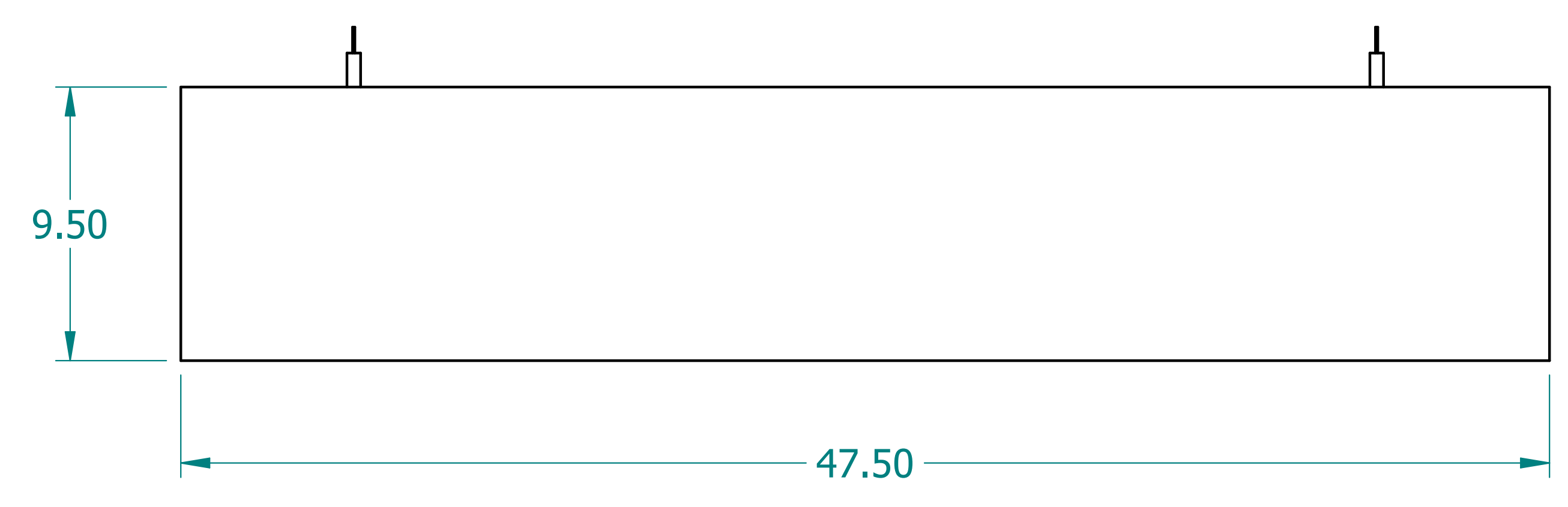
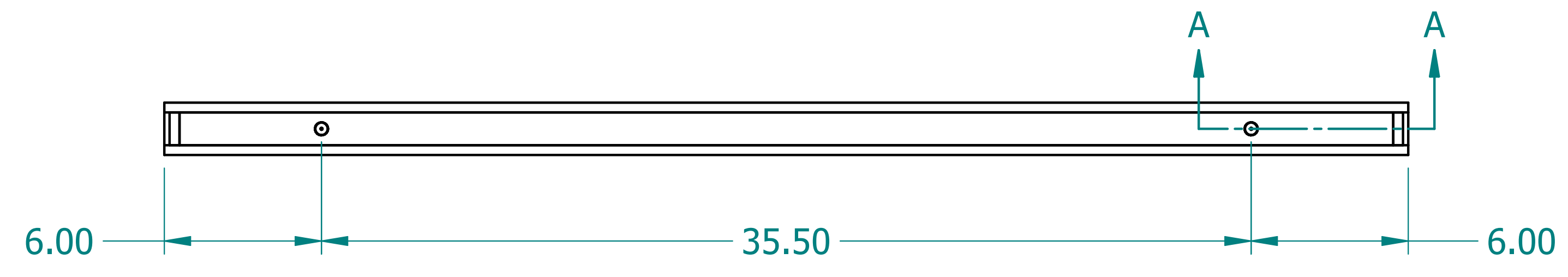
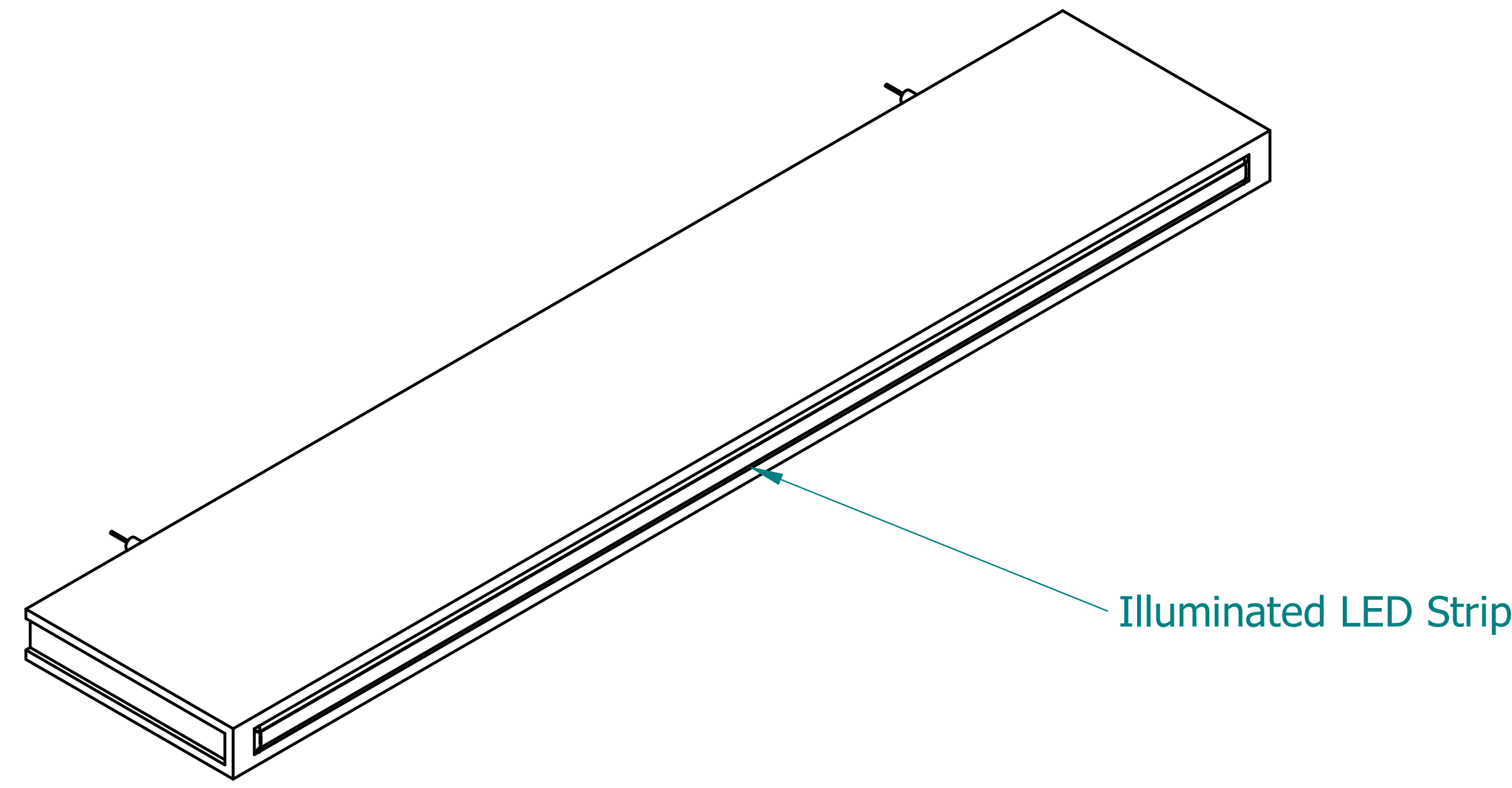

UNLESS OTHERWISE SPECIFIED DIMENSIONS ARE IN 'INCHES'  
 ANGLES  $\pm 0.8^\circ$  ; 2 PL  $\pm 0.040$  ;  
 3 PL  $\pm 0.020$

TITLE <b>Illuminated Acoustic Blade</b>	
SUBTITLE 48"x10"x2"	
PART NO: IXABlade-023-XX	REV. 1.0
SIZE: 34"x22"	SCALE: 0.25
SHEET 1 OF 1	
FILE NAME: Illuminated Acoustic Blade (48.10.2).dft	