

REVISION HISTORY			
REV.	DESCRIPTION	DATE	APPROVED

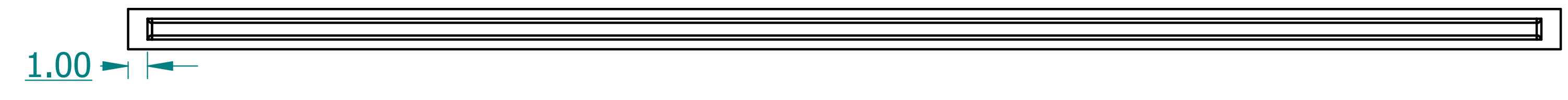

	NAME	DATE
DRAWN	CBS	11/01/23
ENG APPR	CBS	11/01/23

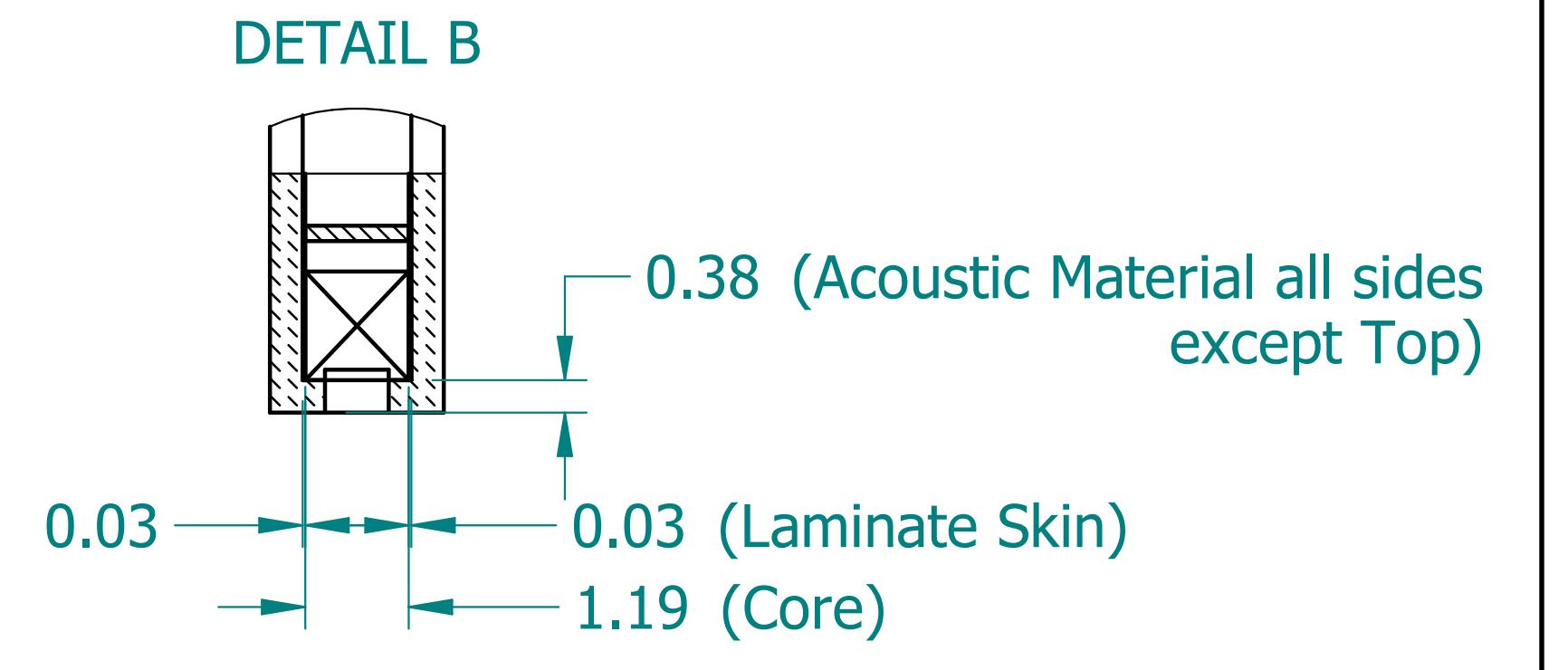
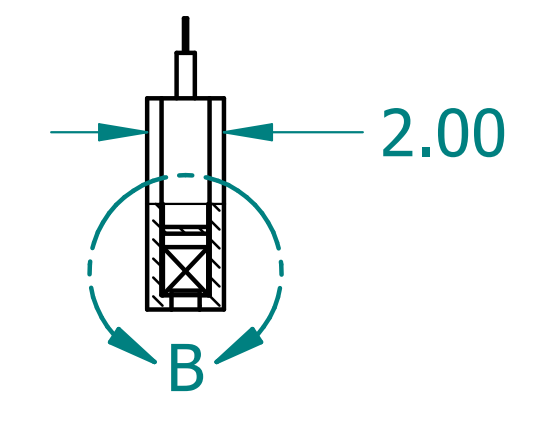
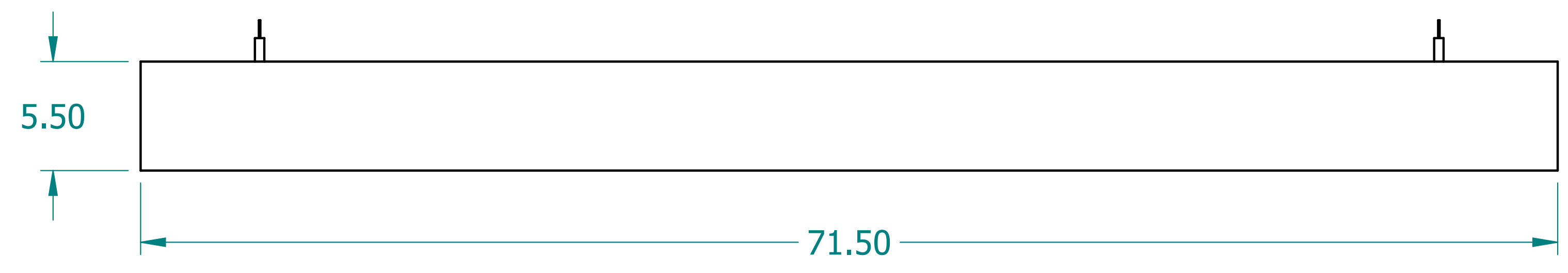
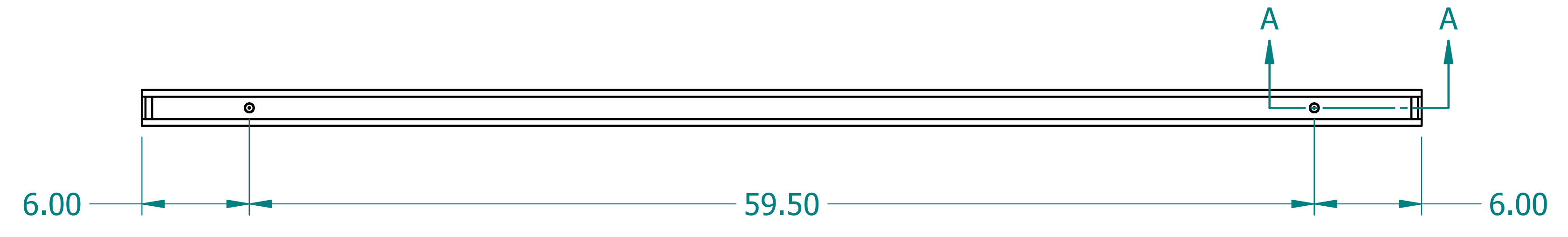
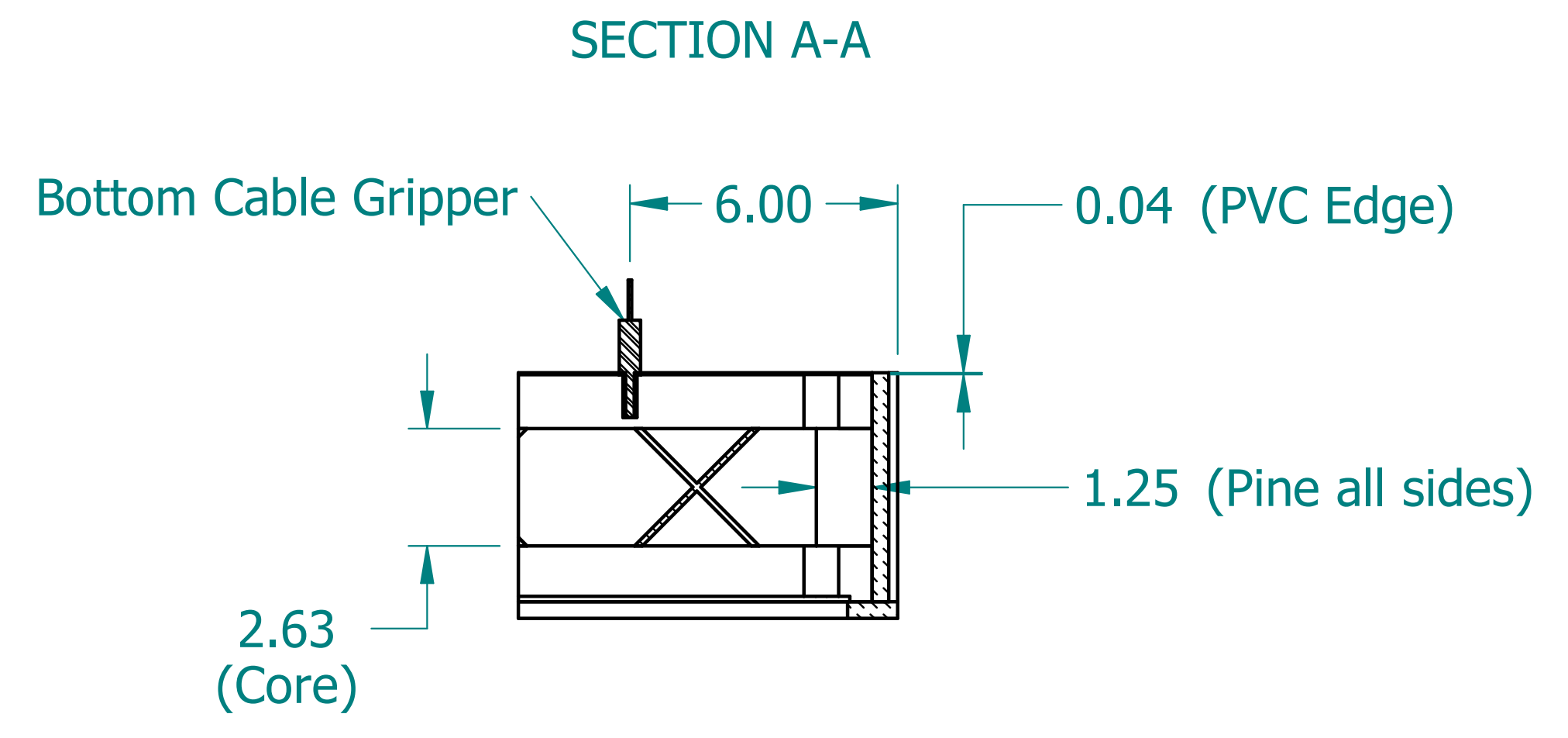
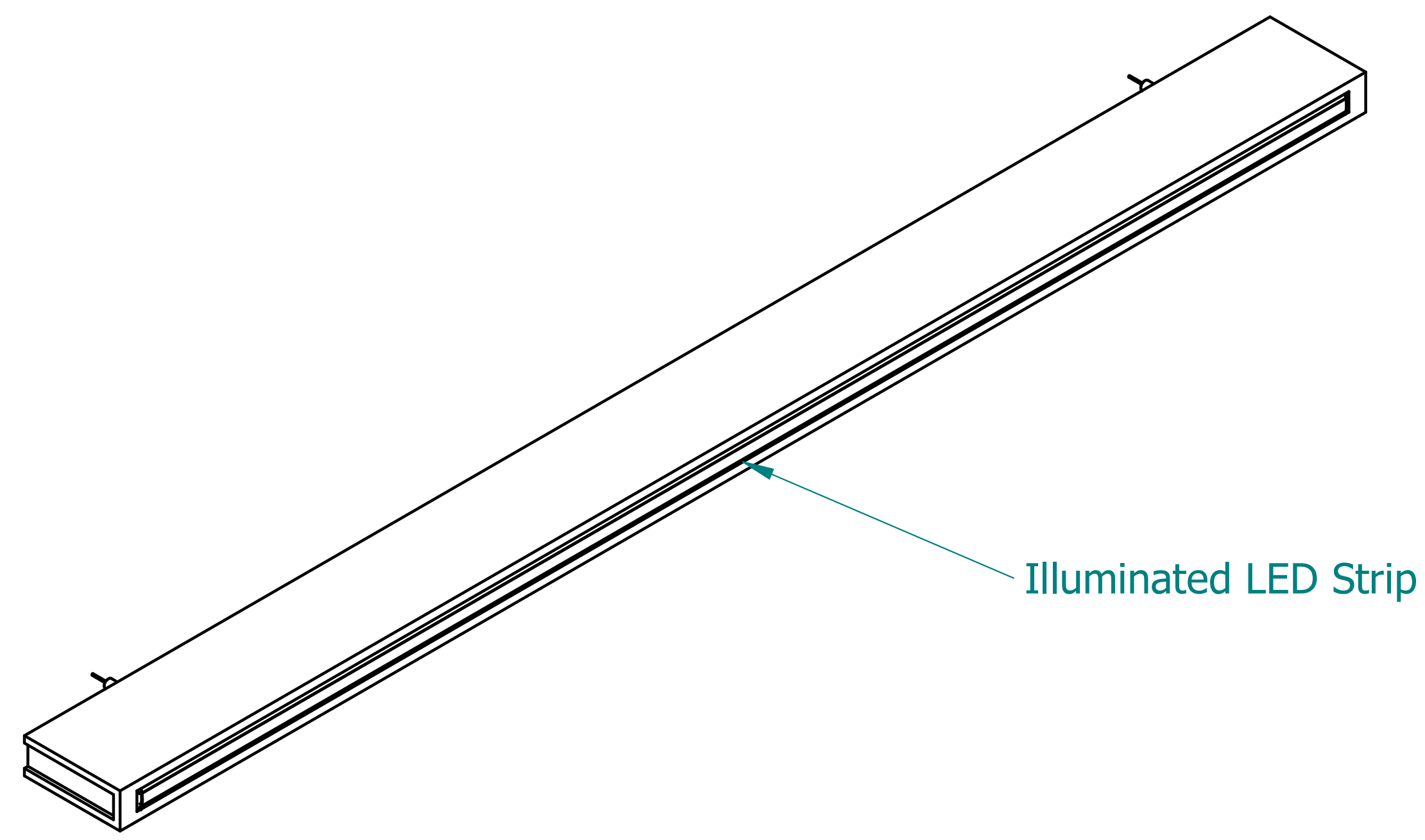

UNLESS OTHERWISE SPECIFIED DIMENSIONS ARE IN 'INCHES'
 ANGLES $\pm 0.8^\circ$; 2 PL ± 0.040 ;
 3 PL ± 0.020

TITLE Illuminated Acoustic Blade	
SUBTITLE 72"x6"x2"	
PART NO: IXABlade-037-XX	REV. 1.0
SIZE: 34"x22"	SCALE: 0.20
SHEET 1 OF 1	
FILE NAME: Illuminated Acoustic Blade (72.6.2).dft	