

REVISION HISTORY			
REV.	DESCRIPTION	DATE	APPROVED

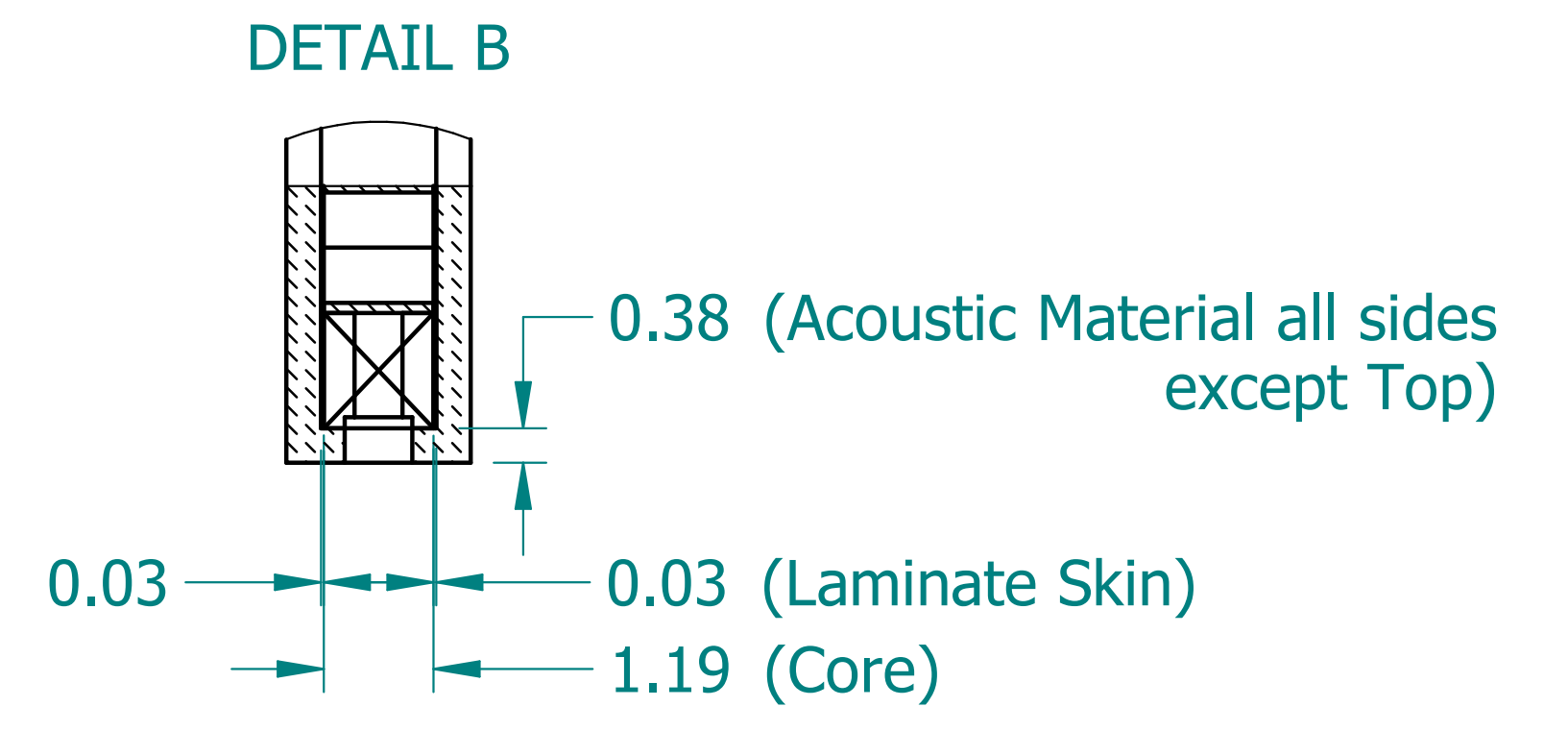
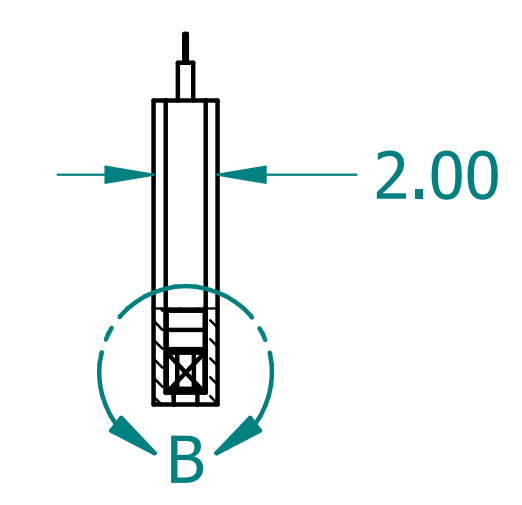
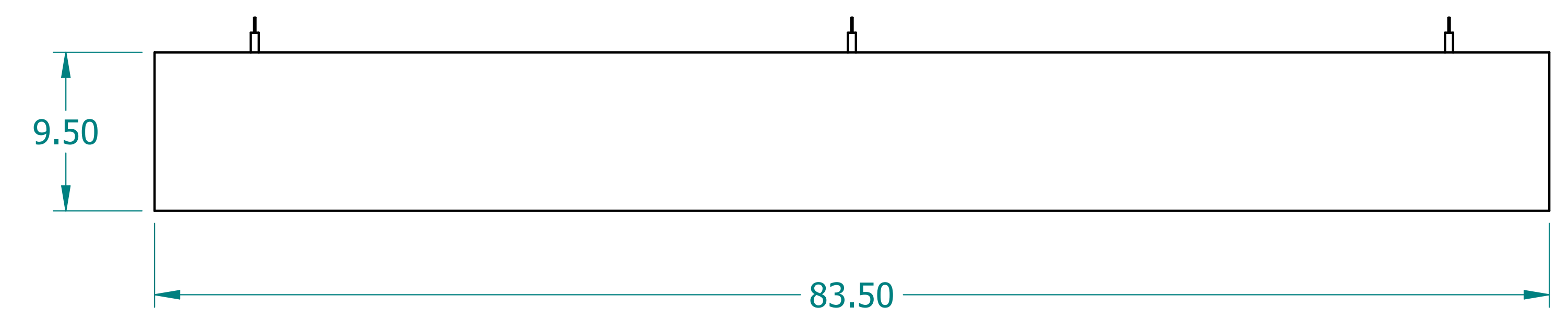
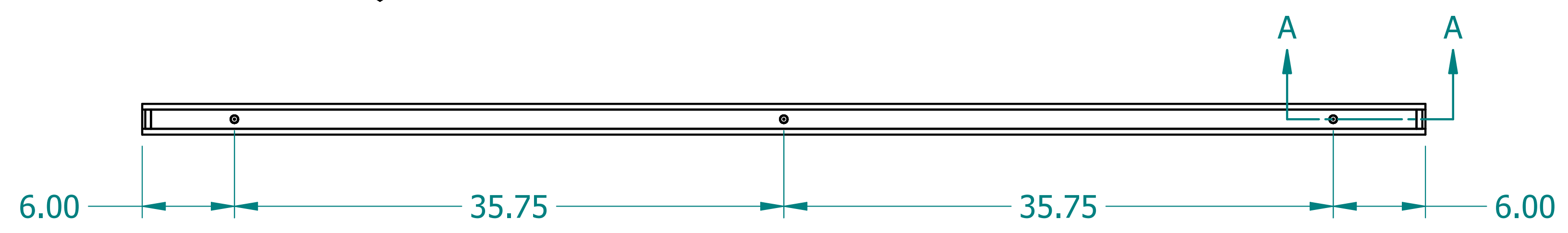
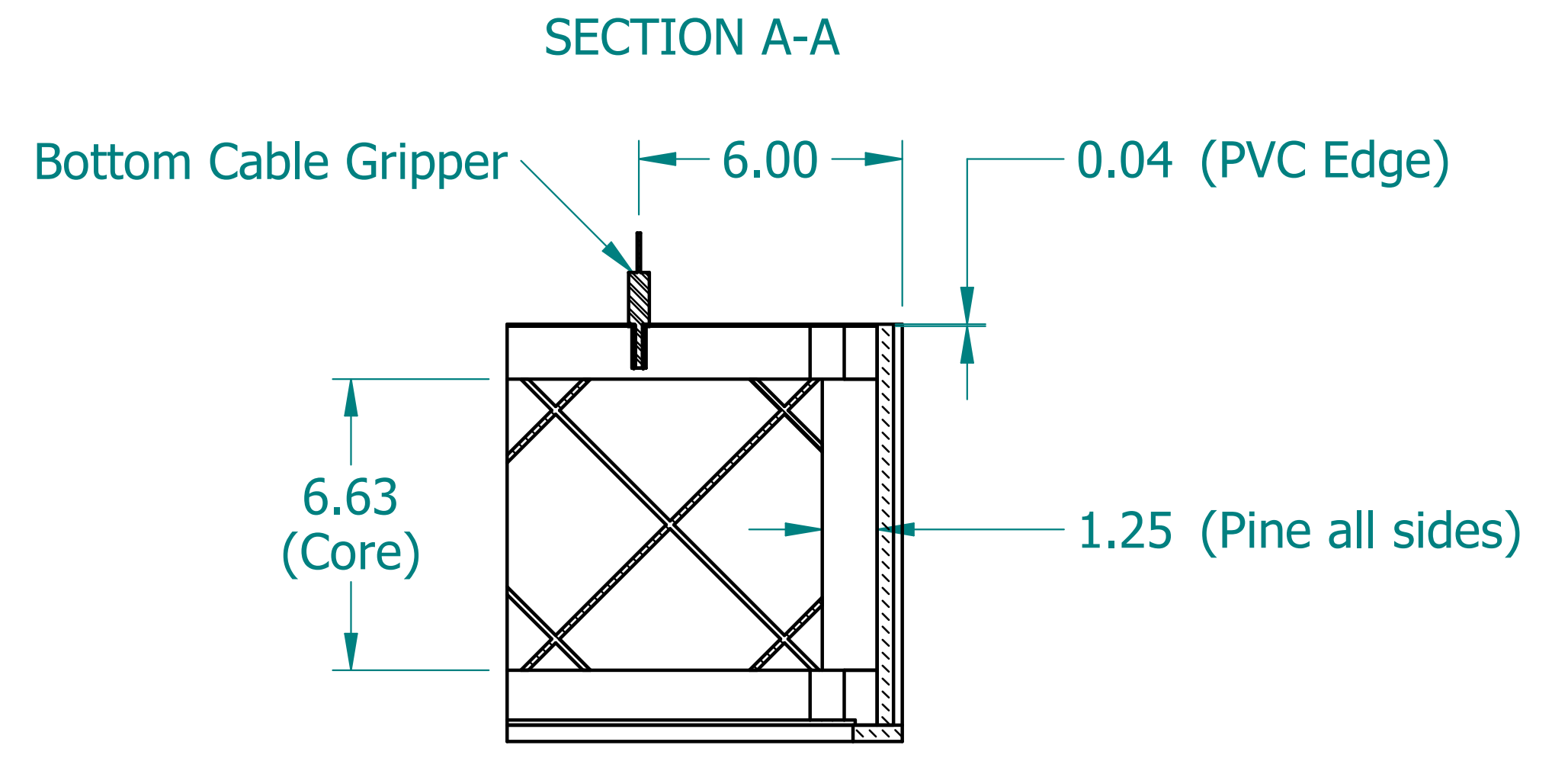
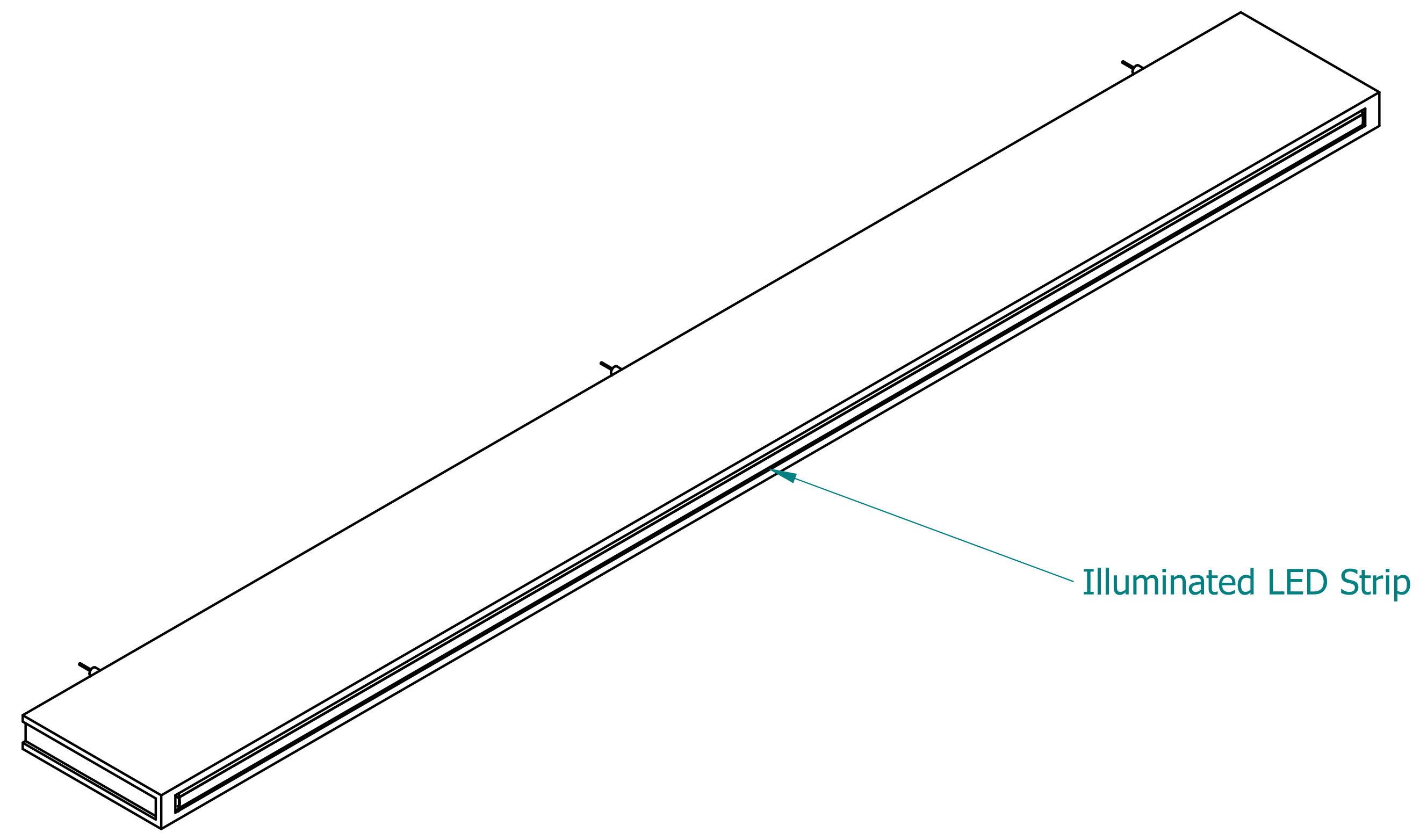

NAME	DATE	ALTISPACE	
DRAWN CBS	11/01/23		
ENG APPR CBS	03/27/24		
		TITLE Illuminated Acoustic Blade	
UNLESS OTHERWISE SPECIFIED DIMENSIONS ARE IN 'INCHES' ANGLES $\pm 0.8^\circ$; 2 PL ± 0.040 ; 3 PL ± 0.020		SUBTITLE 84"x10"x2"	
		PART NO: IXABlade-047-XX	REV. 1.0
		SIZE: 34"x22"	SCALE: 0.17
		SHEET 1 OF 1	
FILE NAME: Illuminated Acoustic Blade (84.10.2).dft			