

REVISION HISTORY			
REV.	DESCRIPTION	DATE	APPROVED

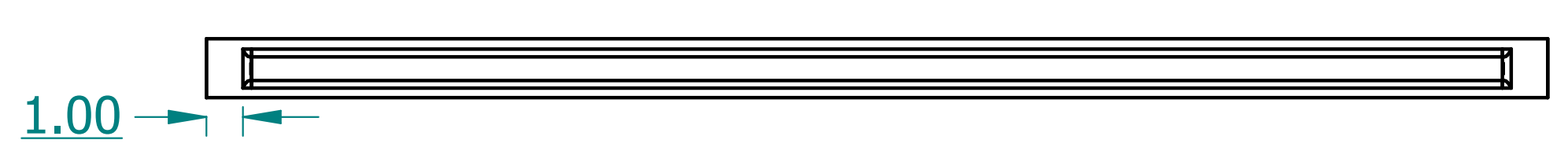
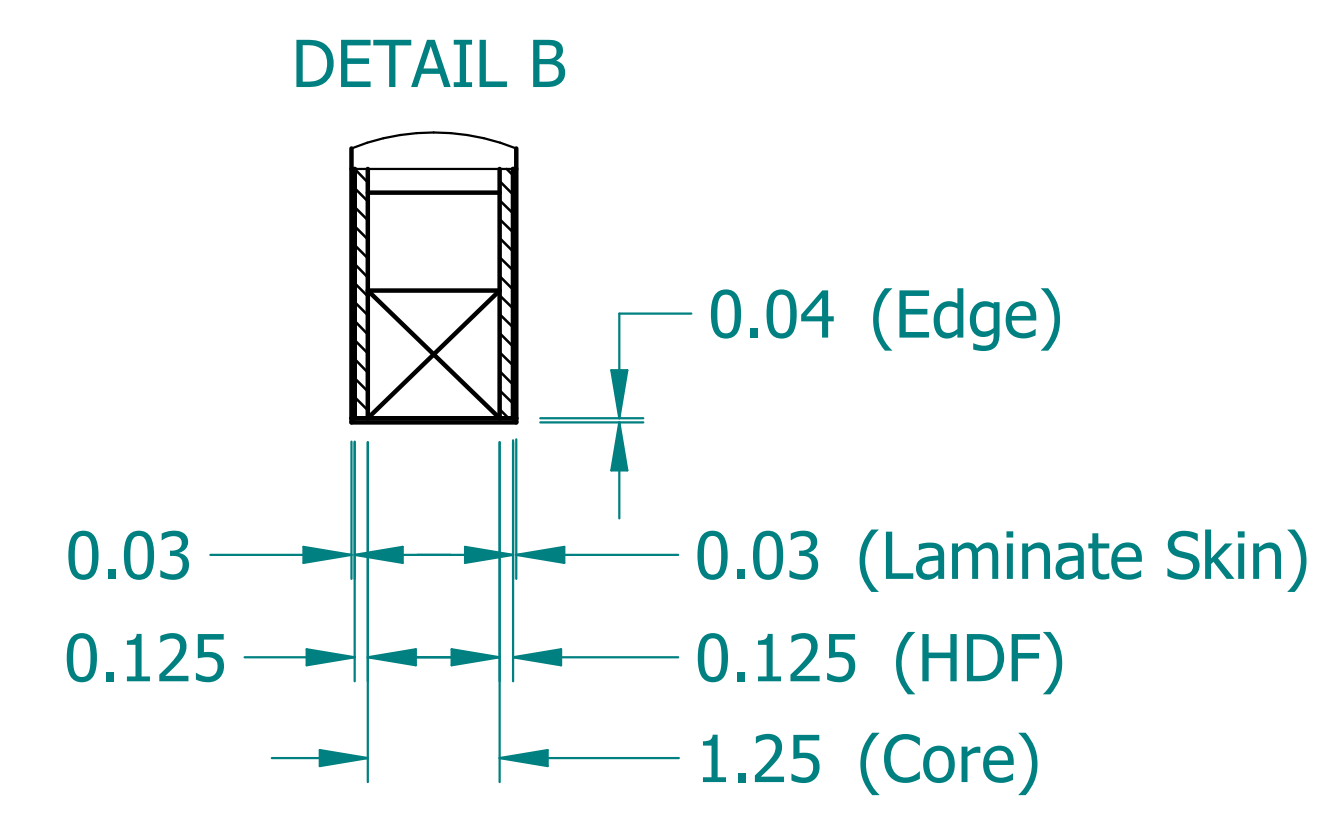
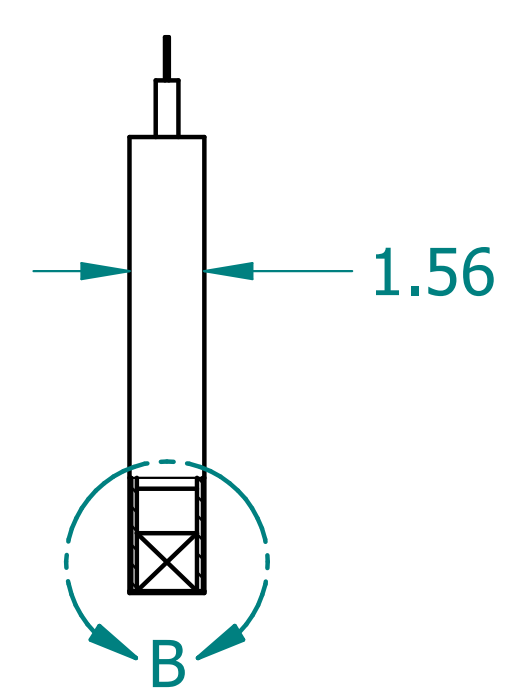
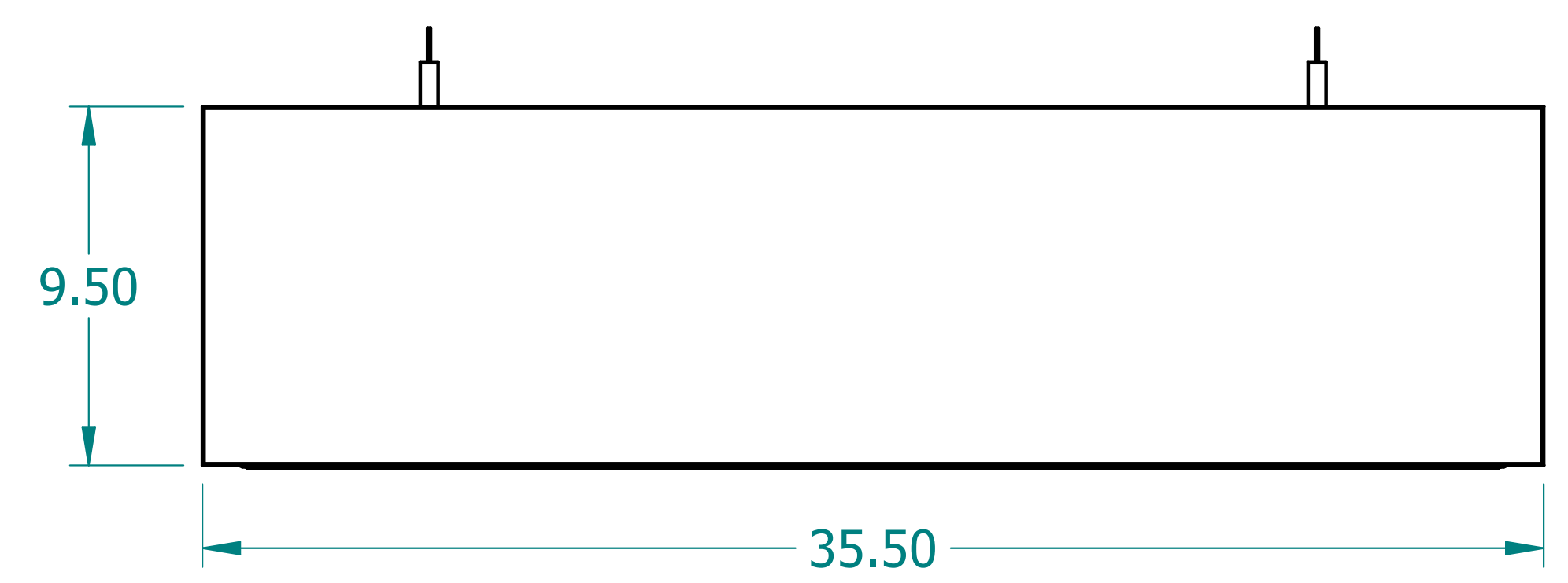
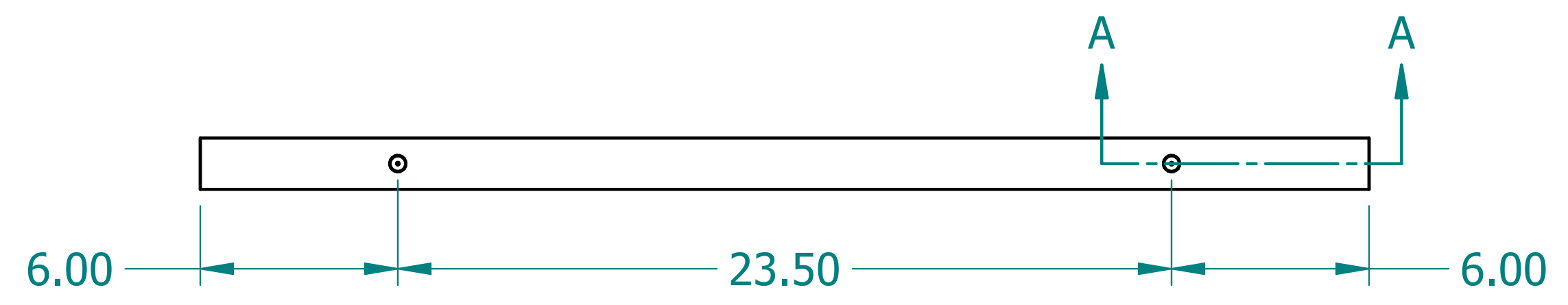
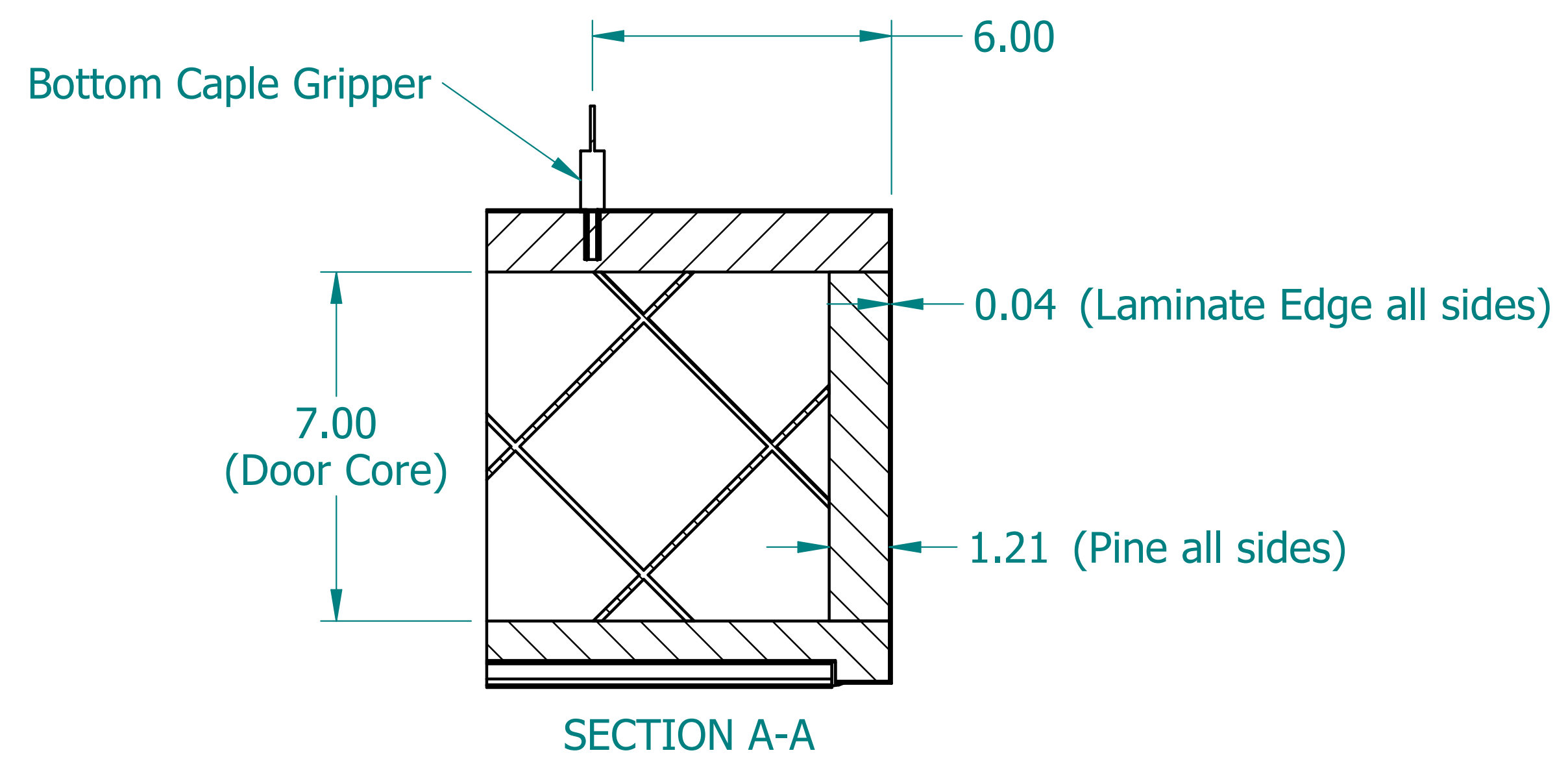
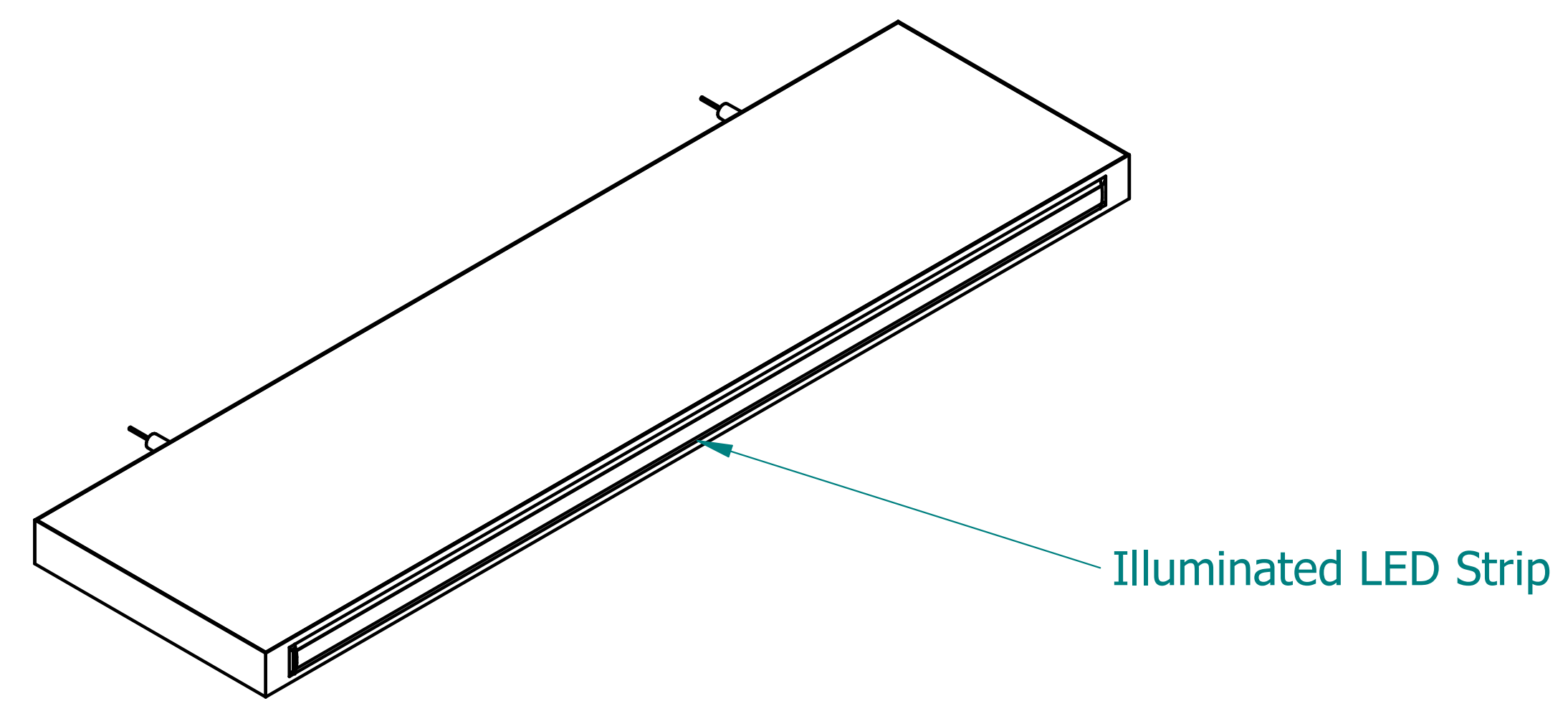

NAME	DATE	
DRAWN CBS	12/13/23	
ENG APPR CBS	12/13/23	
		TITLE Illuminated Laminate Beam
UNLESS OTHERWISE SPECIFIED DIMENSIONS ARE IN 'INCHES' ANGLES $\pm 0.8^\circ$; 2 PL ± 0.040 ; 3 PL ± 0.020		SUBTITLE 36"x10"x1.5"
PART NO: IXBeam-015-XX		REV. 1.0
SIZE: 34"x22"	SCALE: 0.25	SHEET 1 OF 1
FILE NAME: Illuminated Laminated Beam (36.10.1.5).dft		