

REVISION HISTORY			
REV.	DESCRIPTION	DATE	APPROVED

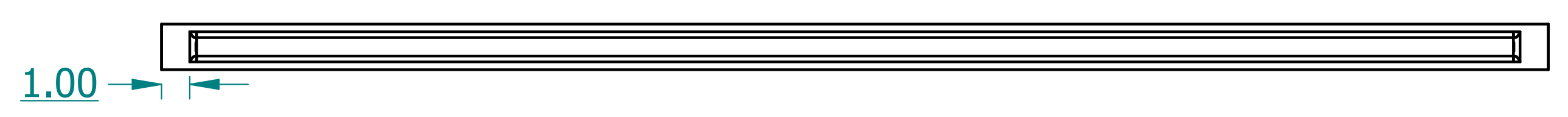
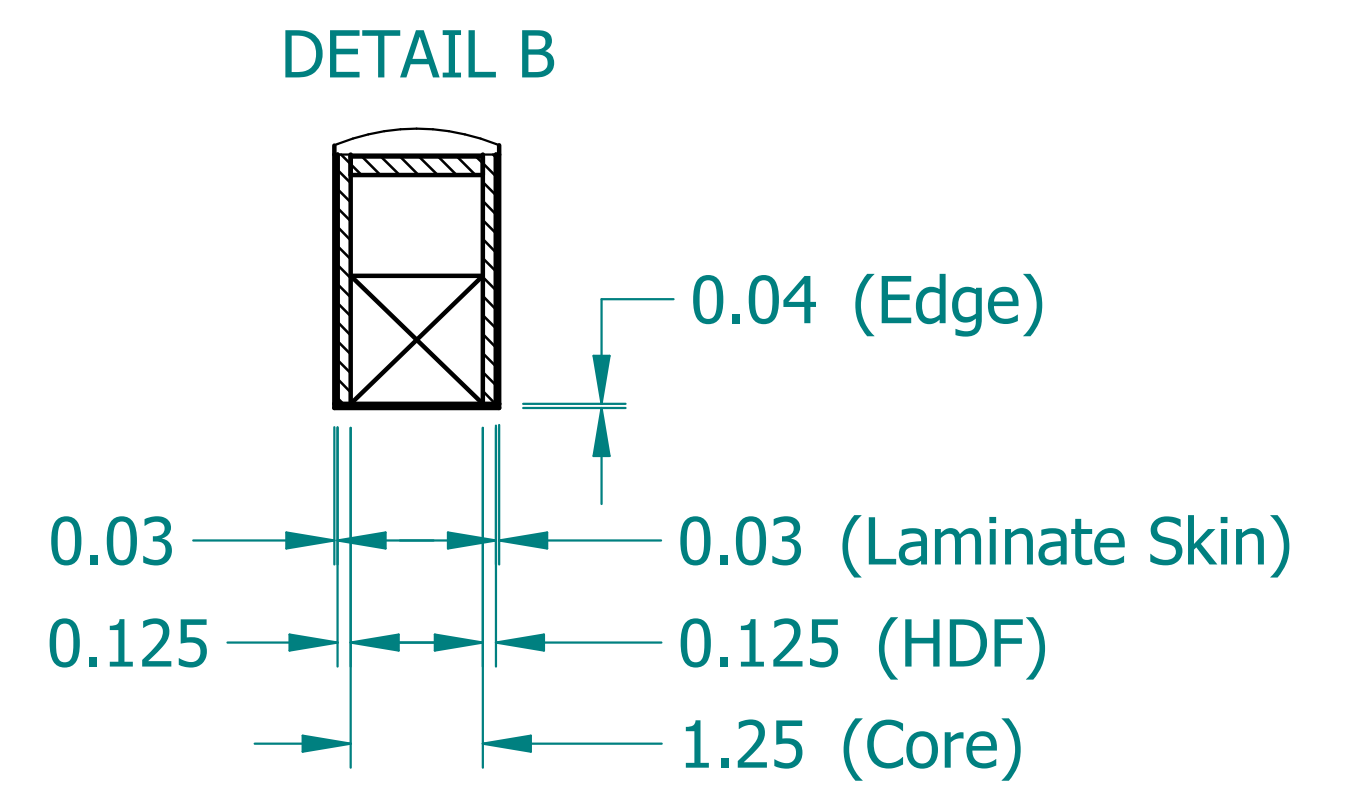
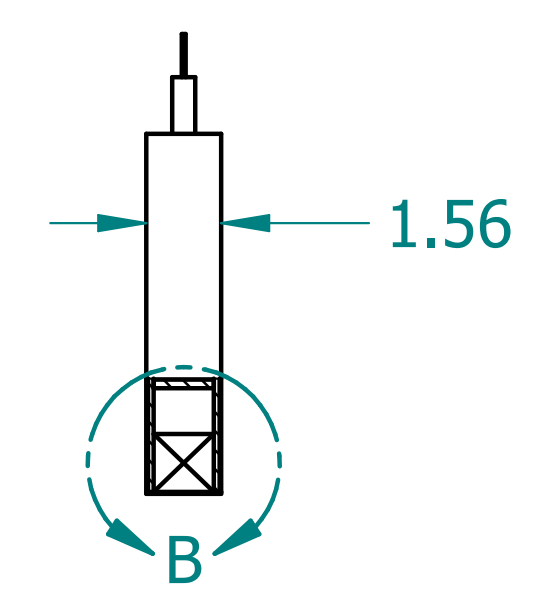
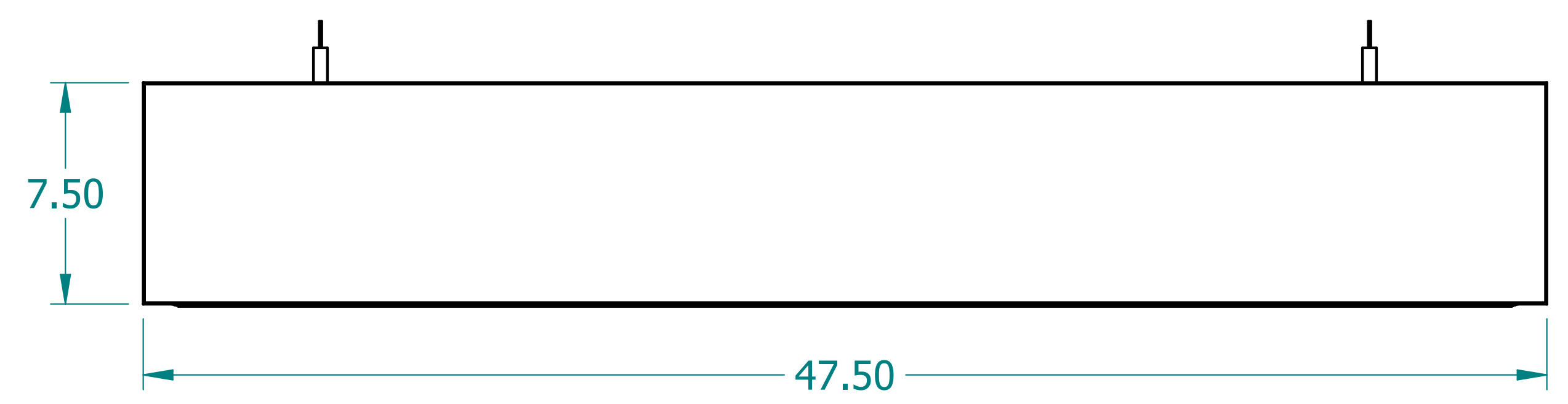
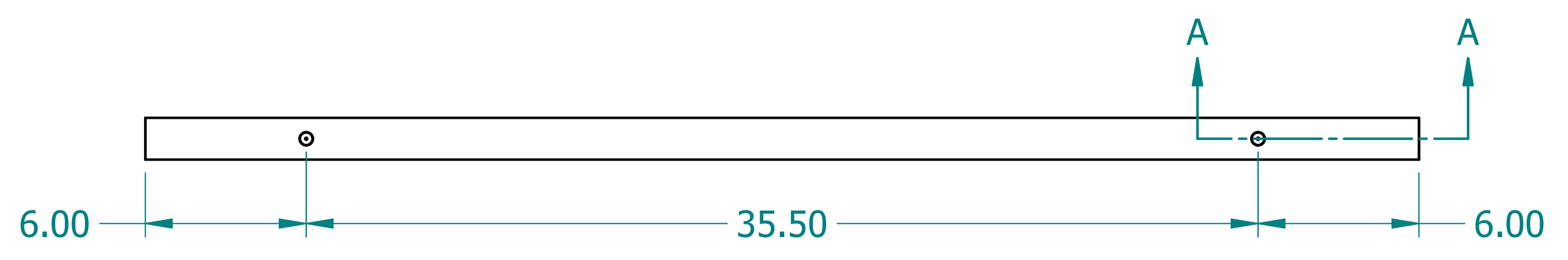
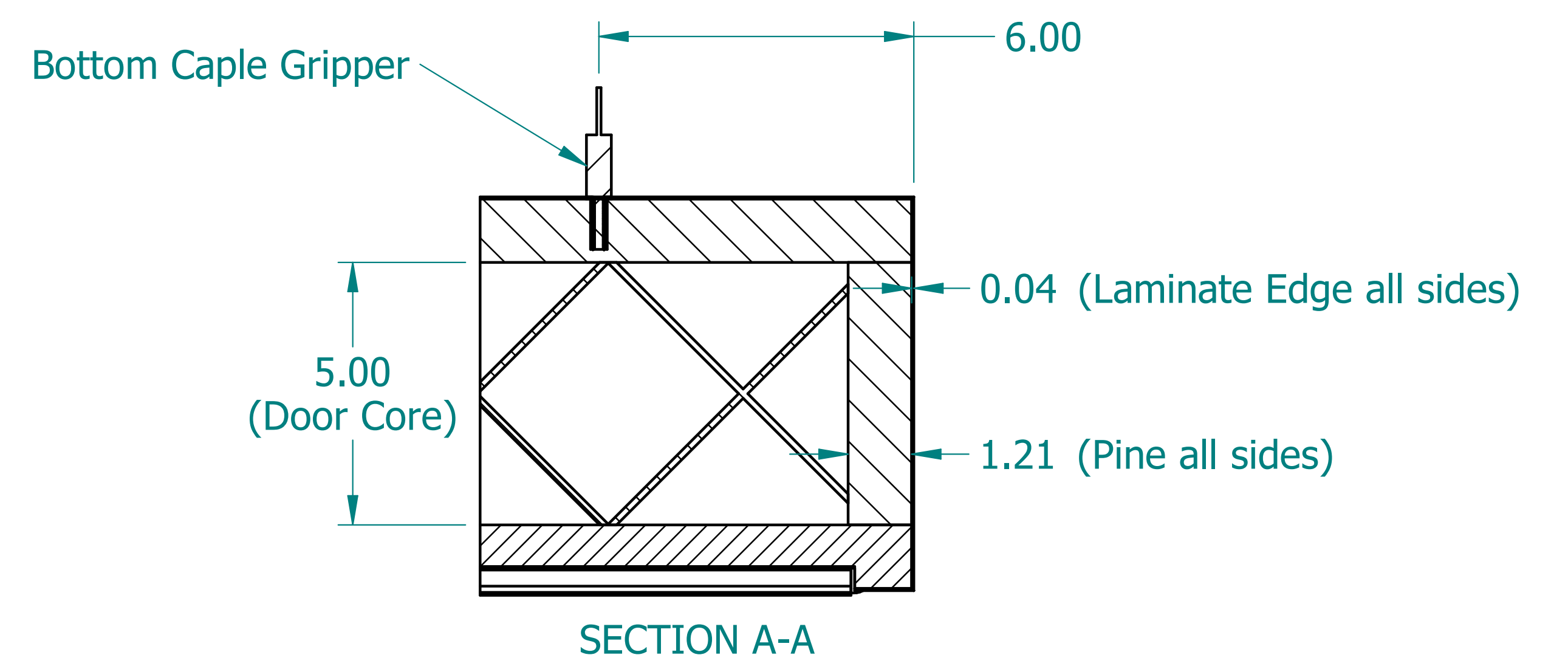
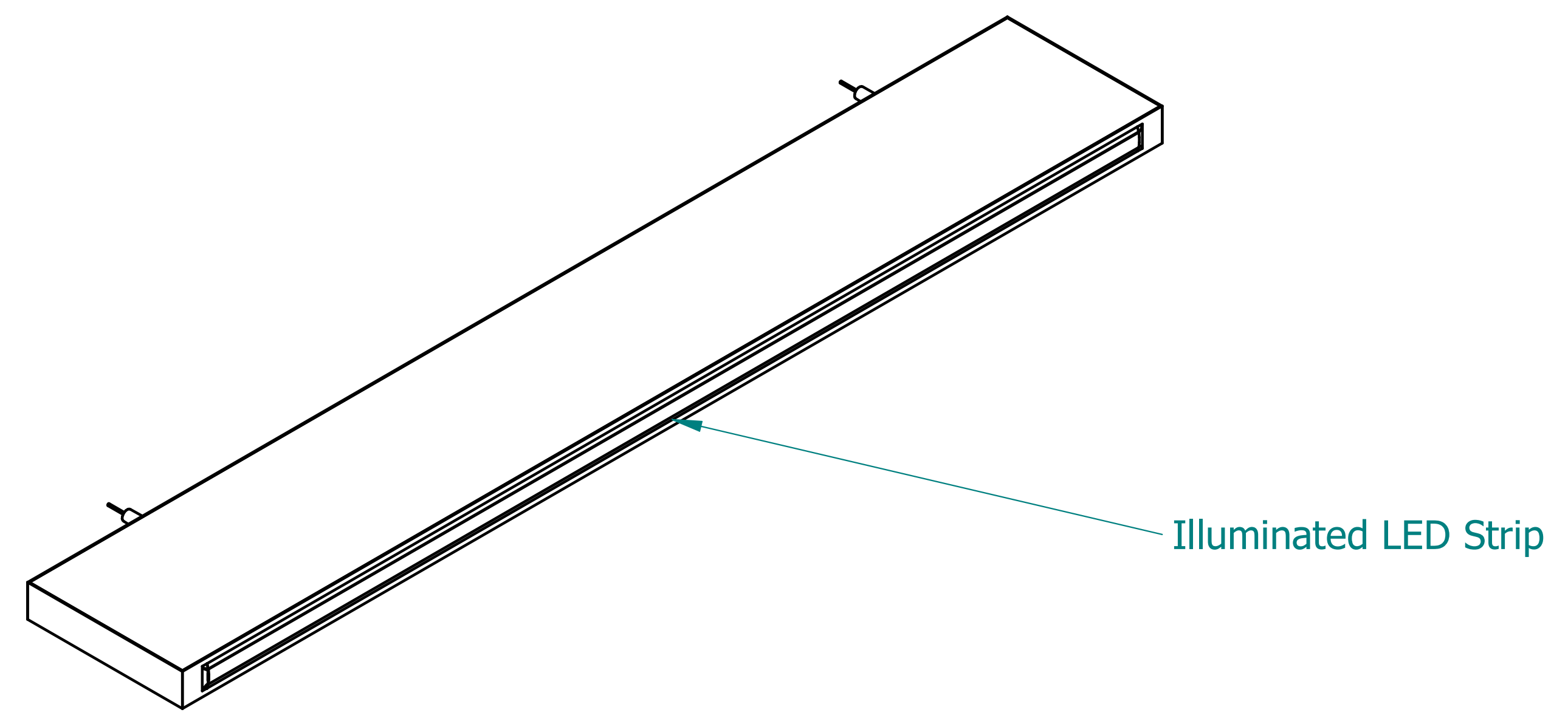

NAME	DATE	
DRAWN CBS	12/14/23	
ENG APPR CBS	12/14/23	
		TITLE
UNLESS OTHERWISE SPECIFIED DIMENSIONS ARE IN 'INCHES' ANGLES $\pm 0.8^\circ$ ; 2 PL $\pm 0.040$ ; 3 PL $\pm 0.020$		<b>Illuminated Laminate Beam</b>
		SUBTITLE
		48"x8"x1.5"
		PART NO: IXBeam-026-XX
		REV. 1.0
		SIZE: 34"x22" SCALE: 0.25 SHEET 1 OF 1
		FILE NAME: Illuminated Laminated Beam (48.8.1.5).dft