

REVISION HISTORY			
REV.	DESCRIPTION	DATE	APPROVED

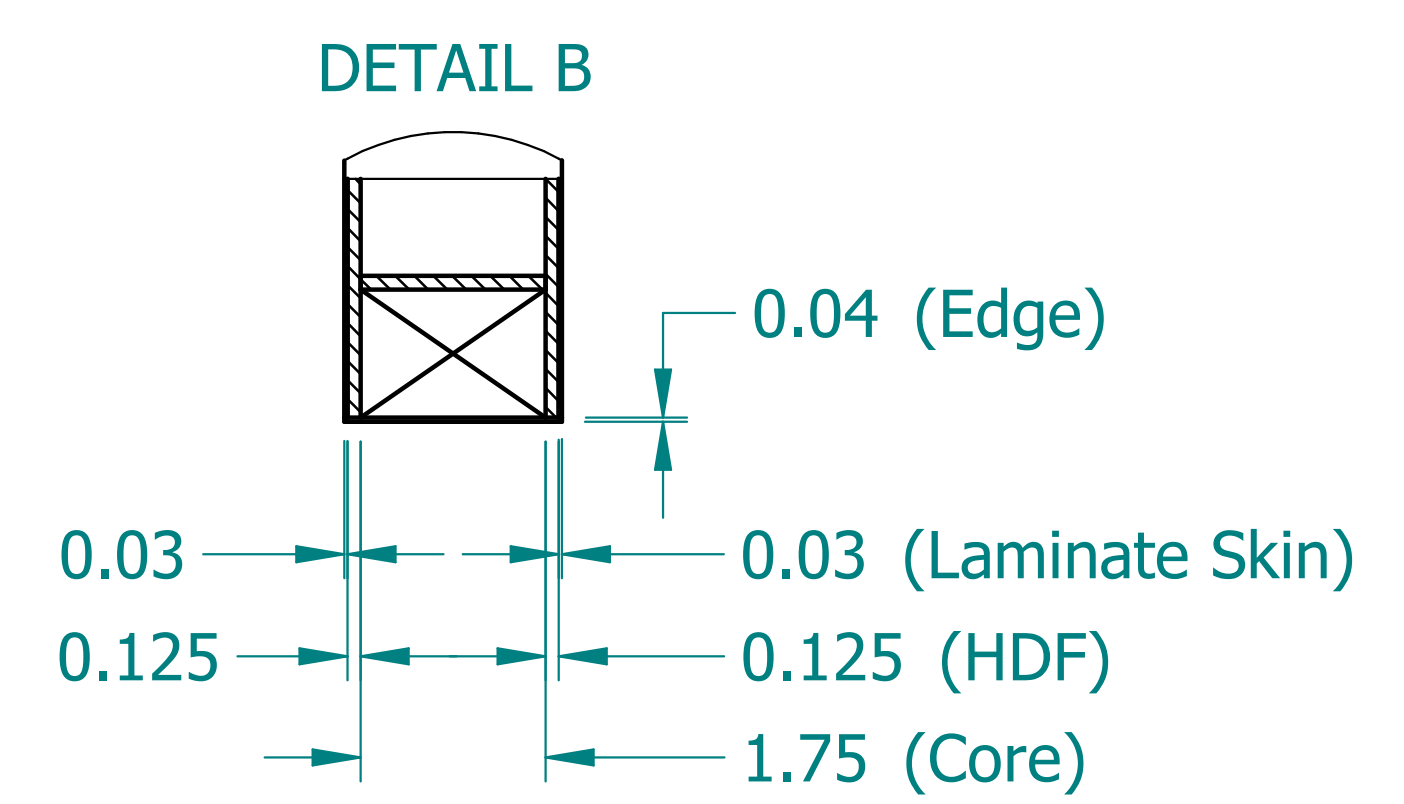
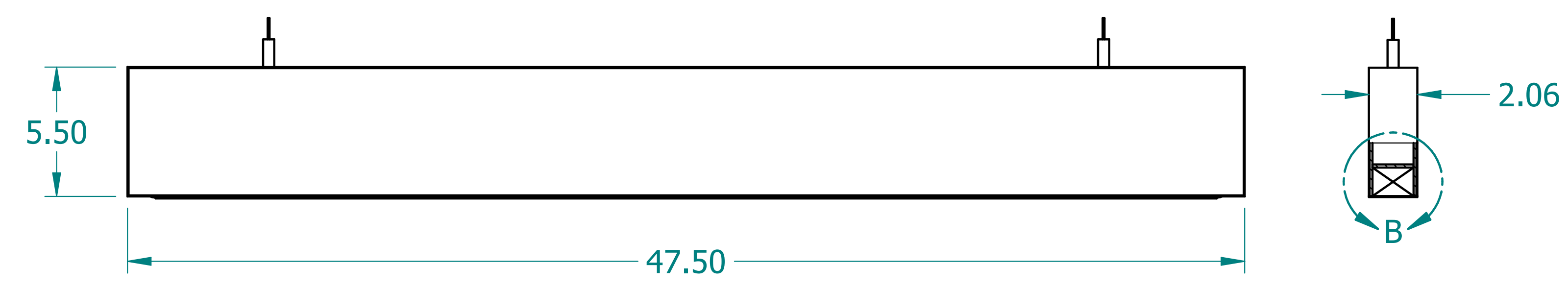
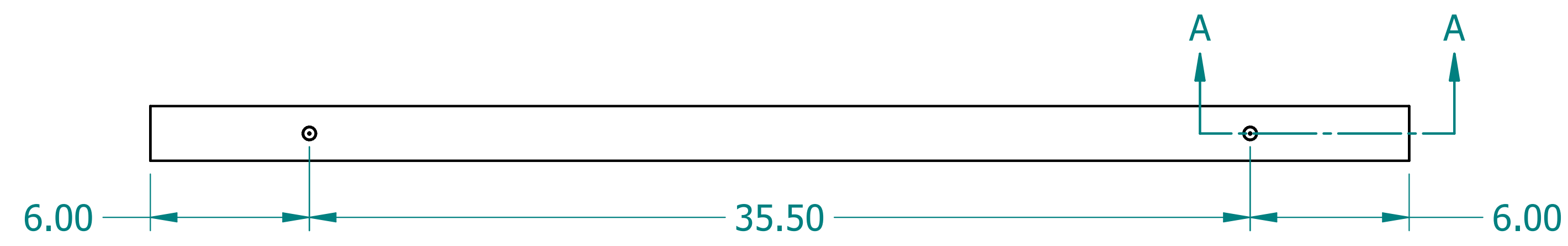
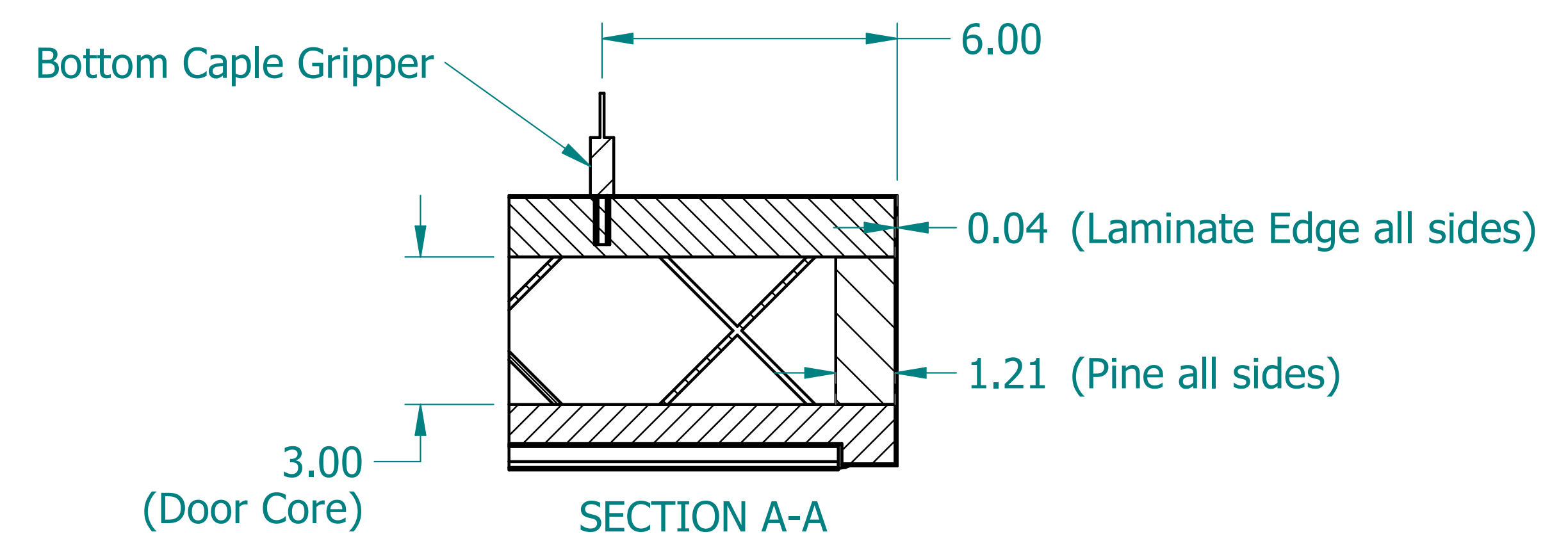
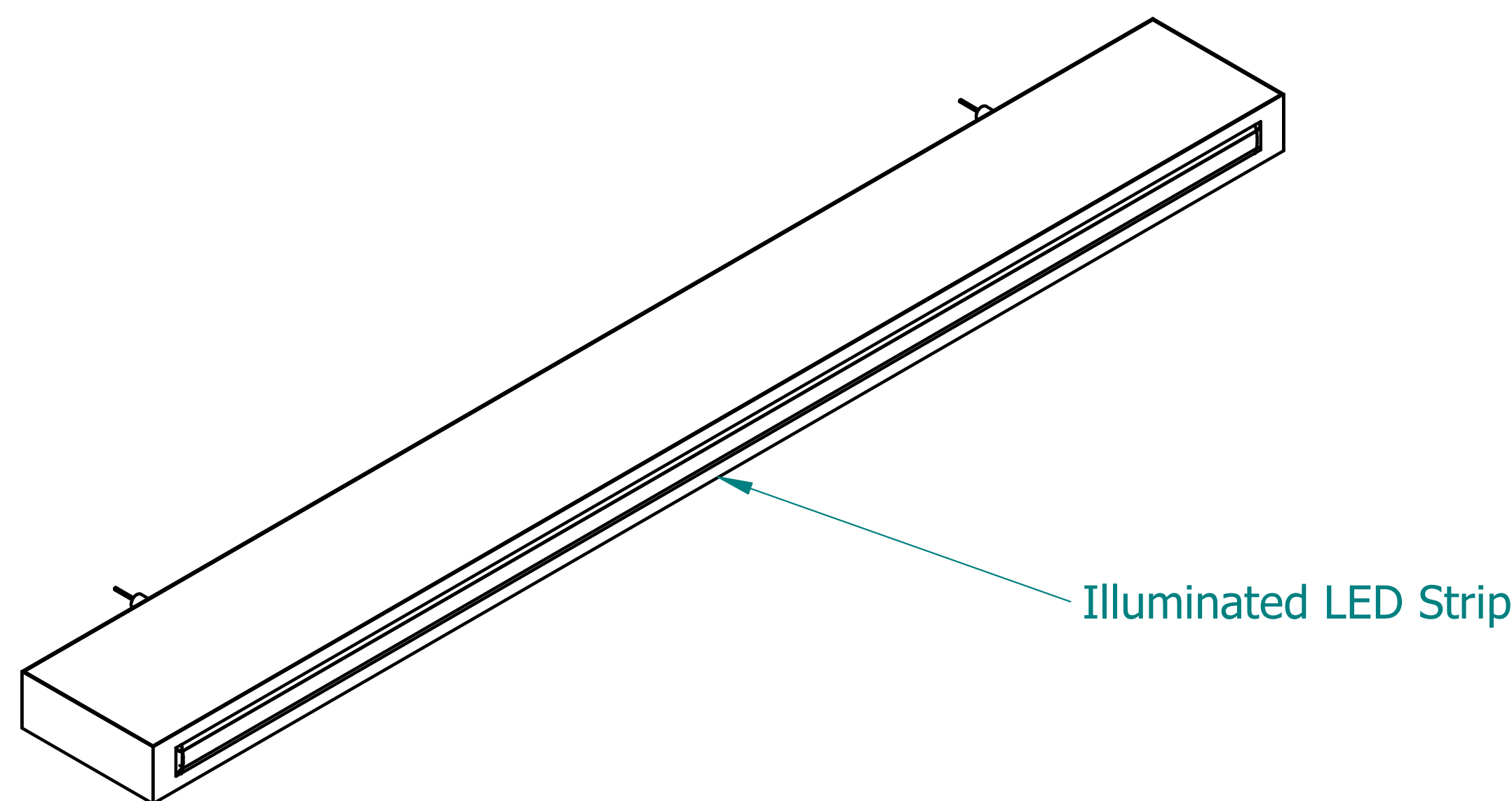

NAME	DATE	
DRAWN CBS	12/06/23	
ENG APPR CBS	12/06/23	
		TITLE
UNLESS OTHERWISE SPECIFIED DIMENSIONS ARE IN 'INCHES' ANGLES $\pm 0.8^\circ$; 2 PL ± 0.040 ; 3 PL ± 0.020		Illuminated Laminate Beam
		SUBTITLE
		48"x6"x2"
		PART NO: IXBeam-029-XX
		REV. 1.0
		SIZE: 34"x22" SCALE: 0.25 SHEET 1 OF 1
		FILE NAME: Illuminated Laminated Beam (48.6.2).dft