

REVISION HISTORY			
REV.	DESCRIPTION	DATE	APPROVED

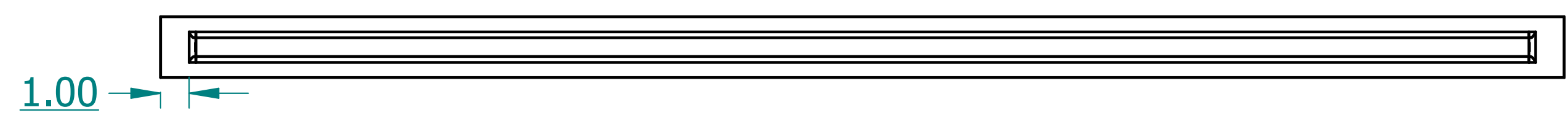
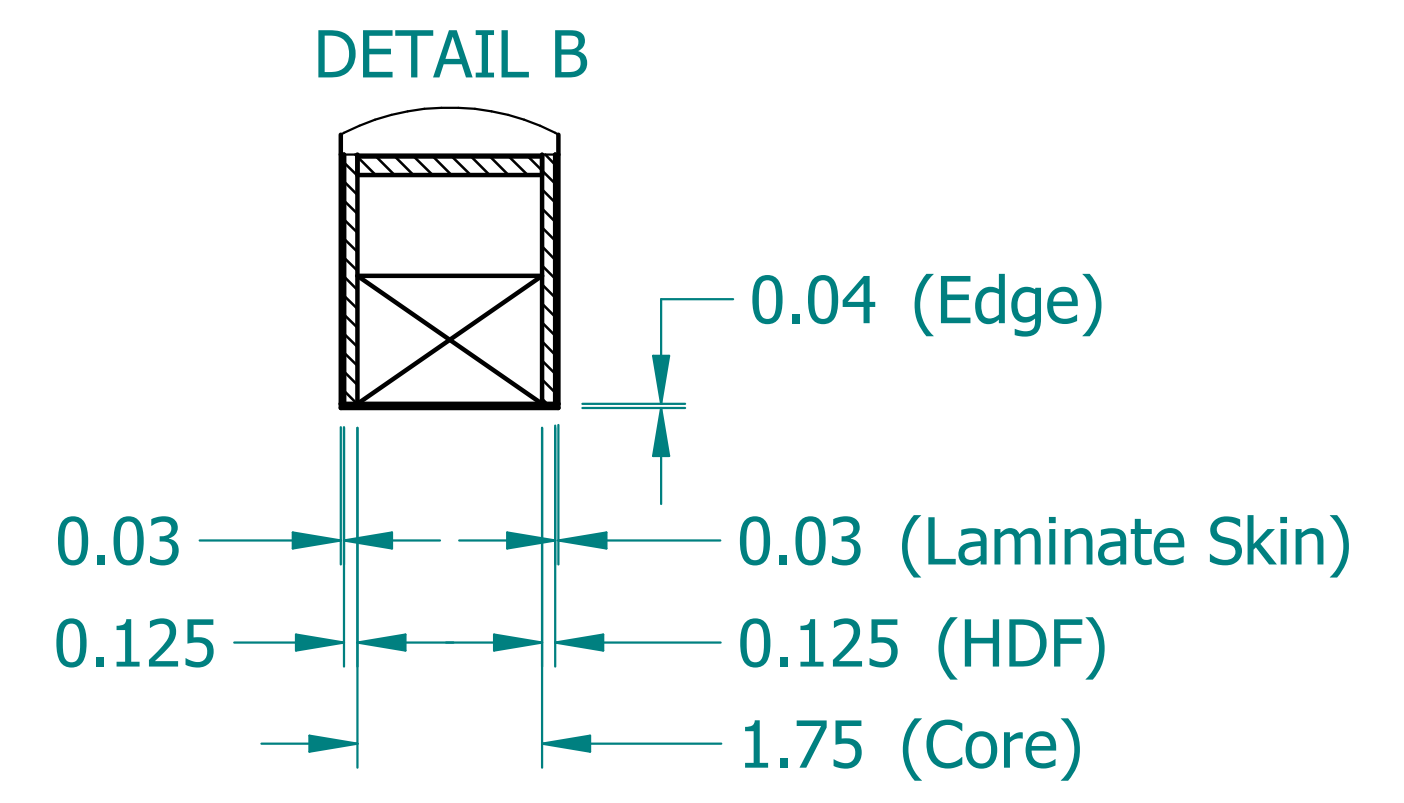
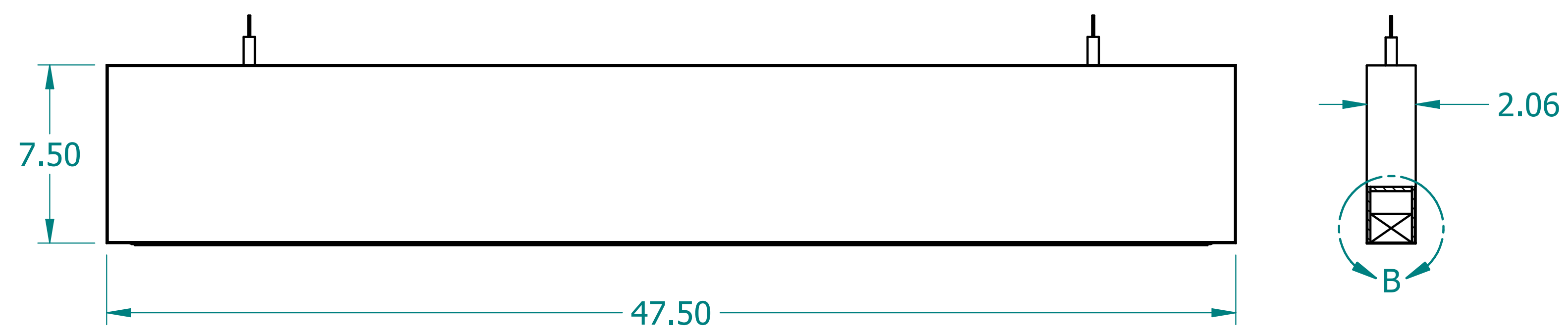
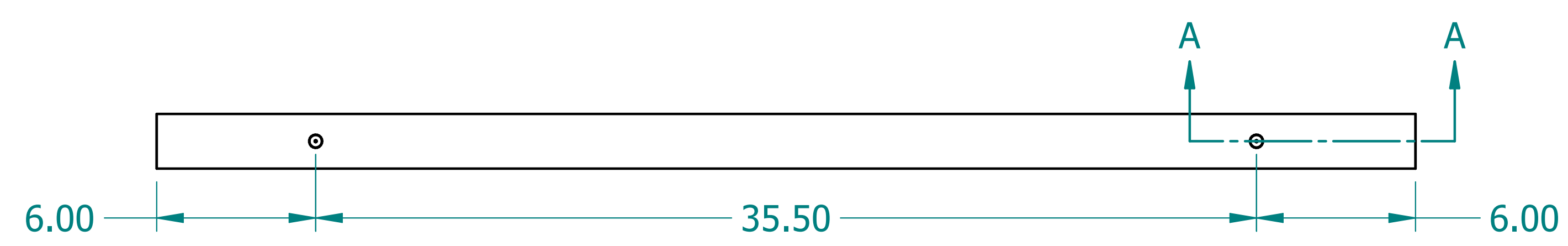
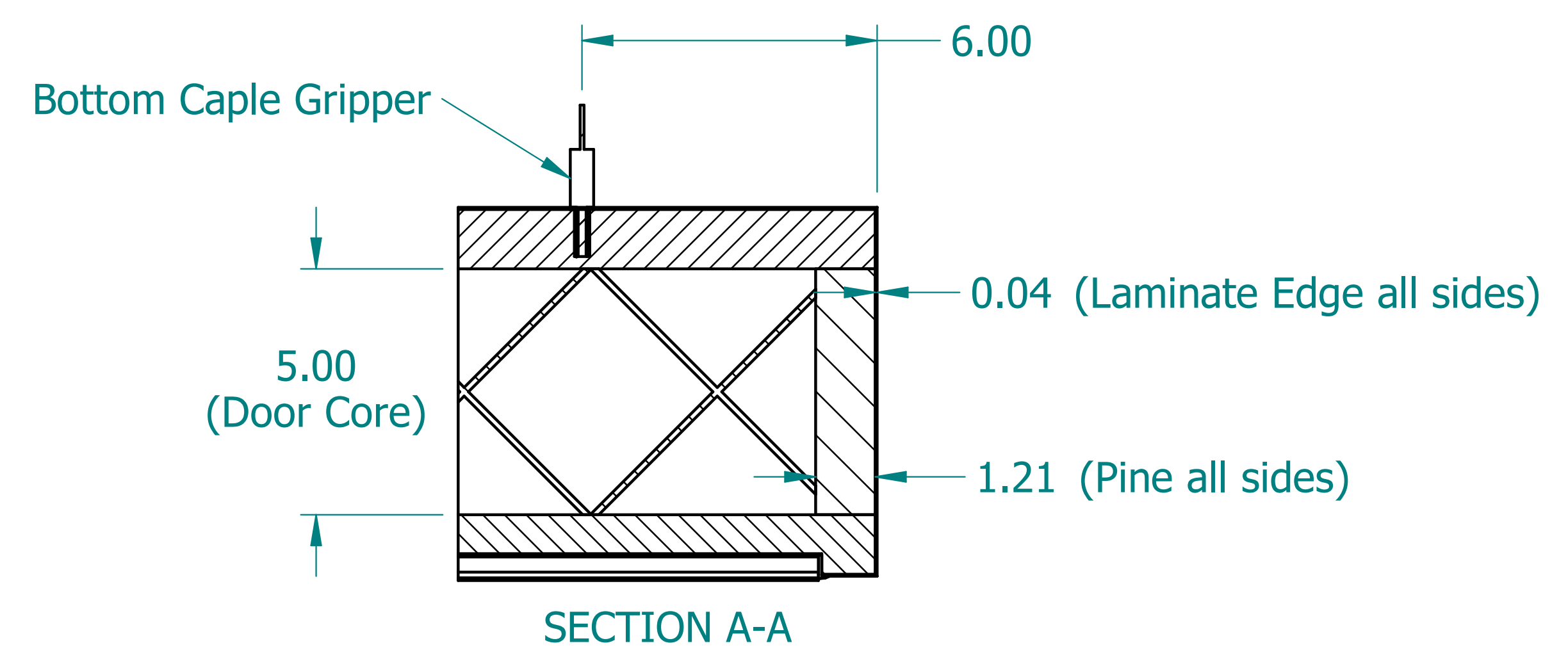
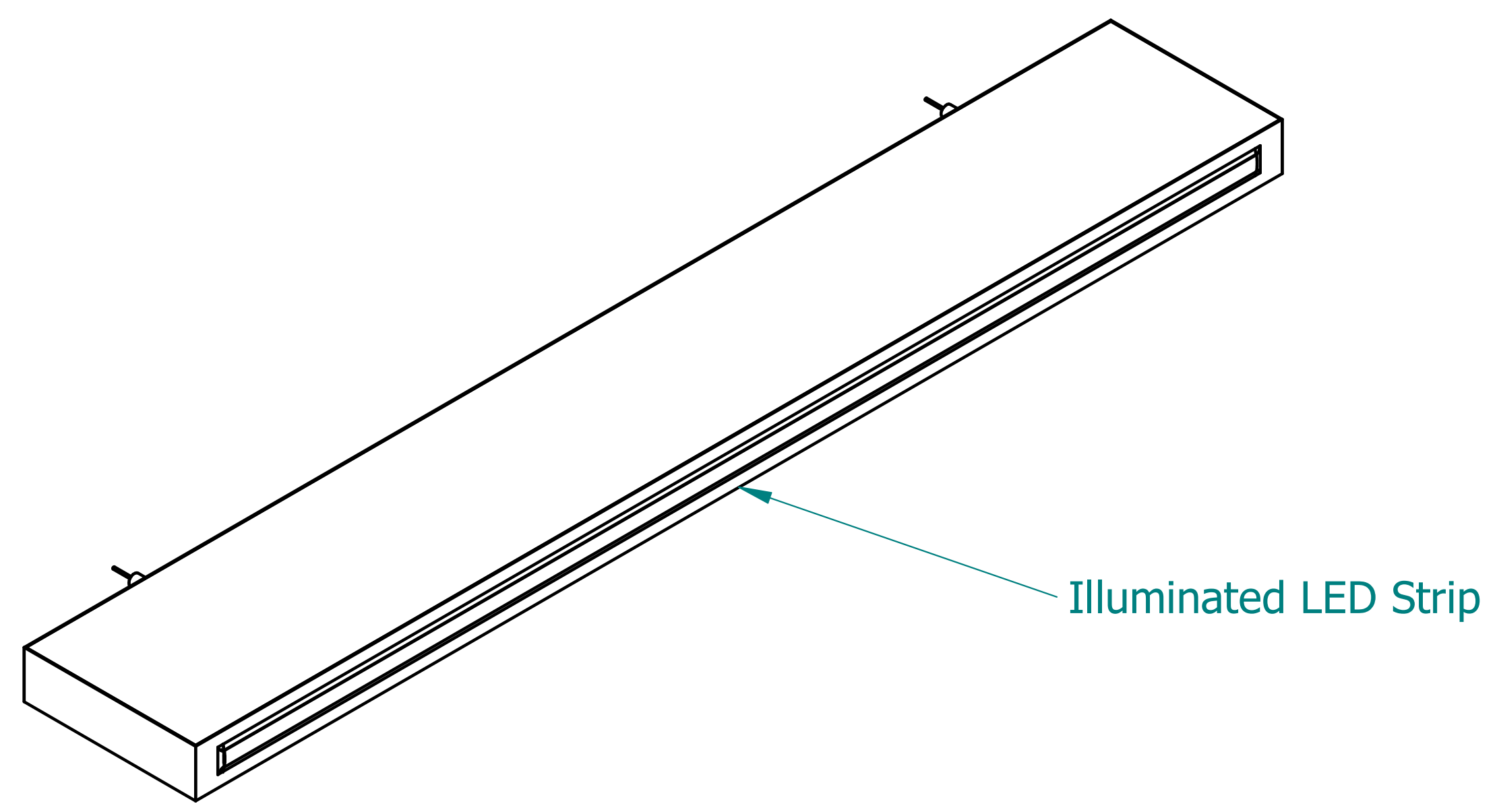

NAME	DATE	
DRAWN CBS	12/06/23	
ENG APPR CBS	12/06/23	
		TITLE
UNLESS OTHERWISE SPECIFIED DIMENSIONS ARE IN 'INCHES'		Illuminated Laminate Beam
ANGLES ±0.8° ; 2 PL ±0.040 ; 3 PL ±0.020		SUBTITLE
		48"x8"x2"
		PART NO: IXBeam-030-XX
		REV. 1.0
		SIZE: 34"x22" SCALE: 0.25 SHEET 1 OF 1
		FILE NAME: Illuminated Laminated Beam (48.8.2).dft