

REVISION HISTORY			
REV.	DESCRIPTION	DATE	APPROVED

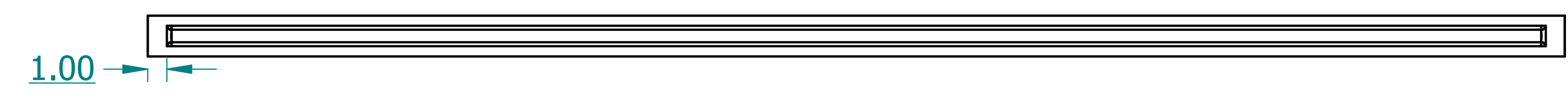

	NAME	DATE
DRAWN	CBS	12/06/23
ENG APPR	CBS	12/06/23

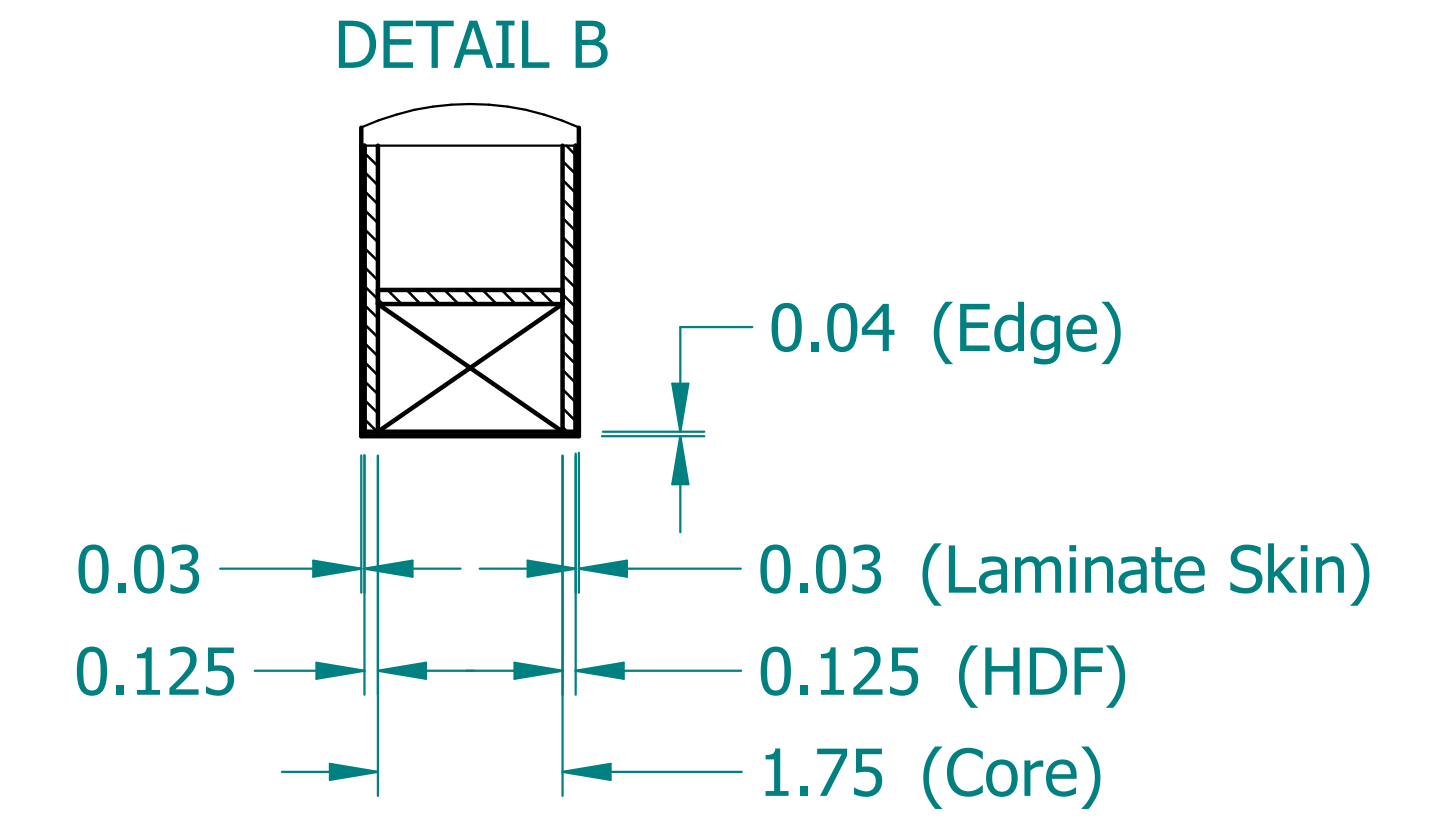
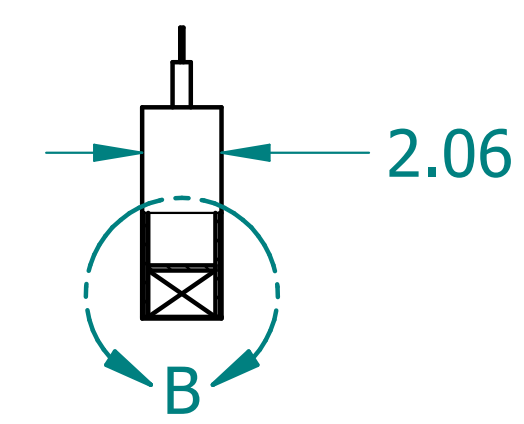
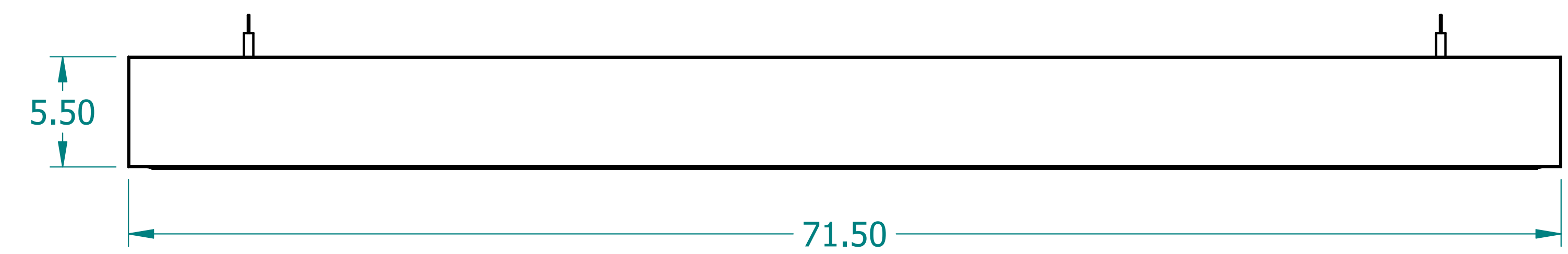
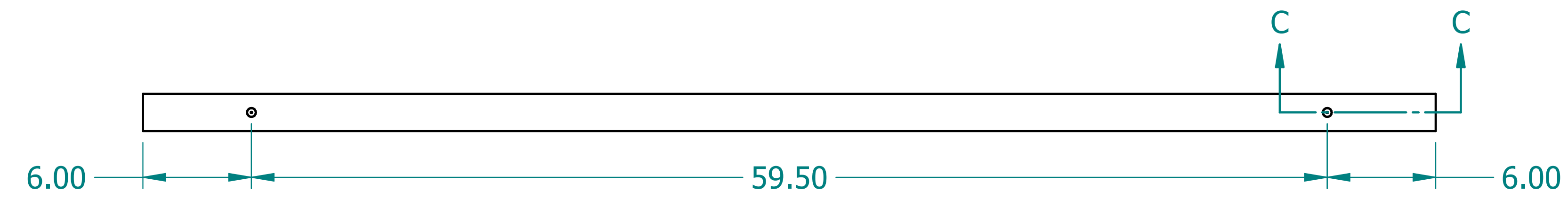
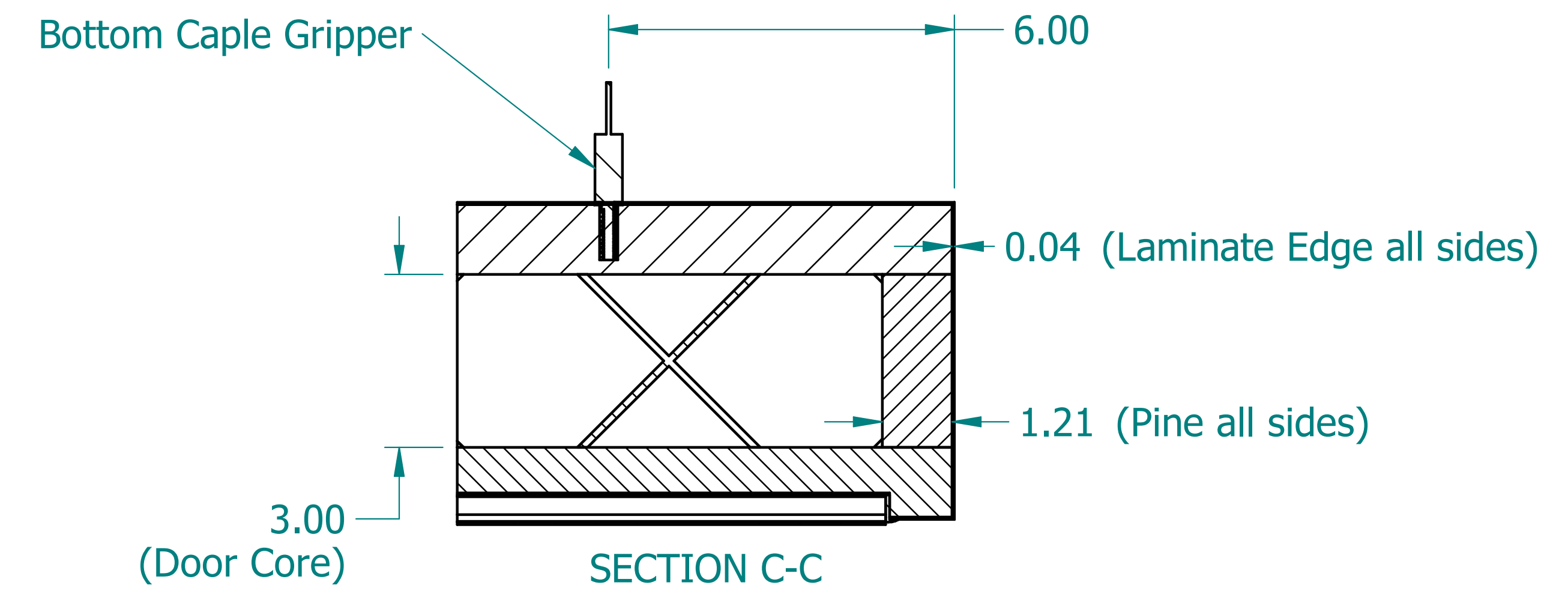
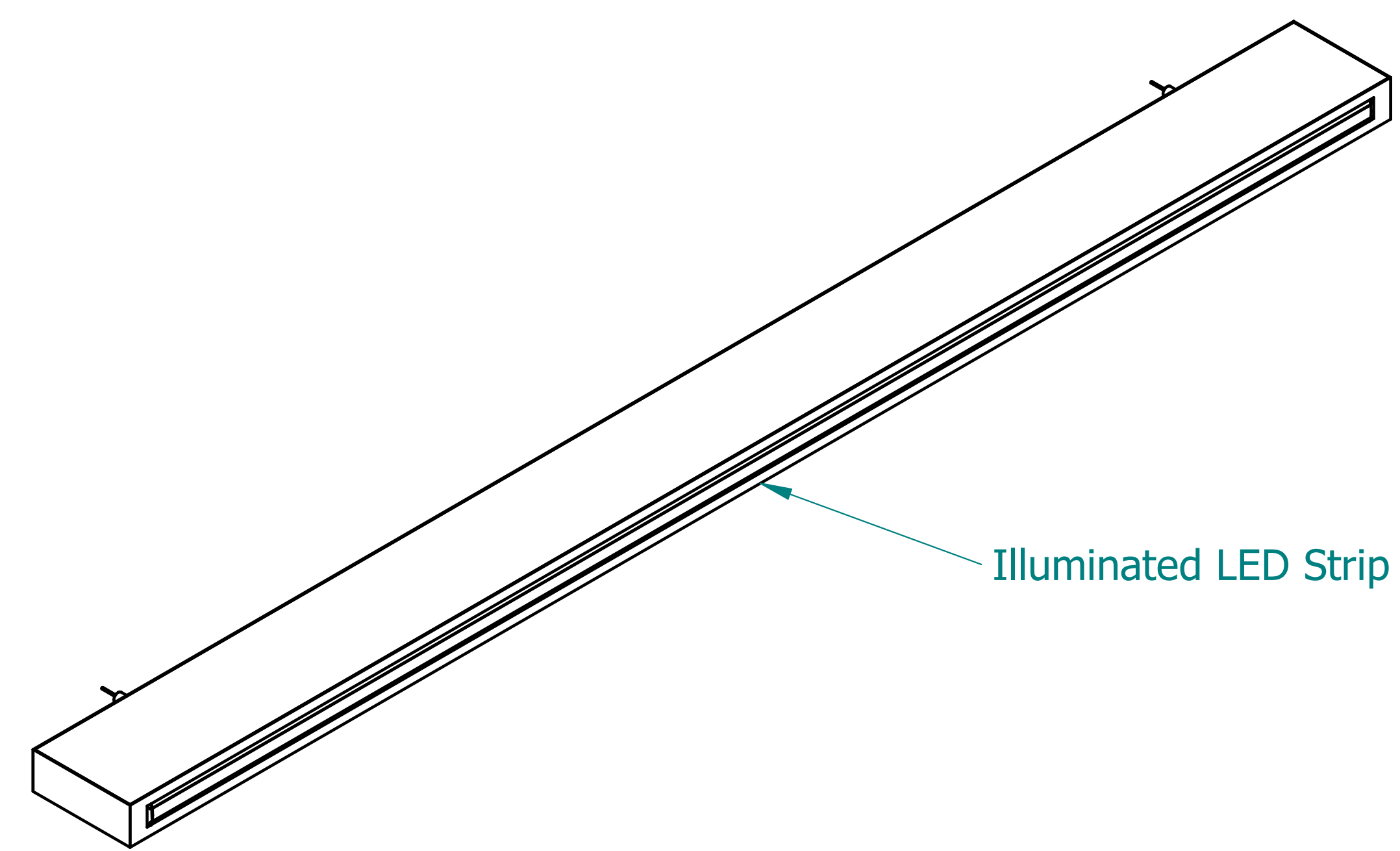

UNLESS OTHERWISE SPECIFIED DIMENSIONS ARE IN 'INCHES'
 ANGLES $\pm 0.8^\circ$; 2 PL ± 0.040 ;
 3 PL ± 0.020

TITLE Illuminated Laminate Beam	
SUBTITLE 72"x6"x2"	
PART NO: IXBeam-053-XX	REV. 1.0
SIZE: 34"x22"	SCALE: 0.20
SHEET 1 OF 1	
FILE NAME: Illuminated Laminated Beam (72.6.2).dft	