

REVISION HISTORY			
REV.	DESCRIPTION	DATE	APPROVED

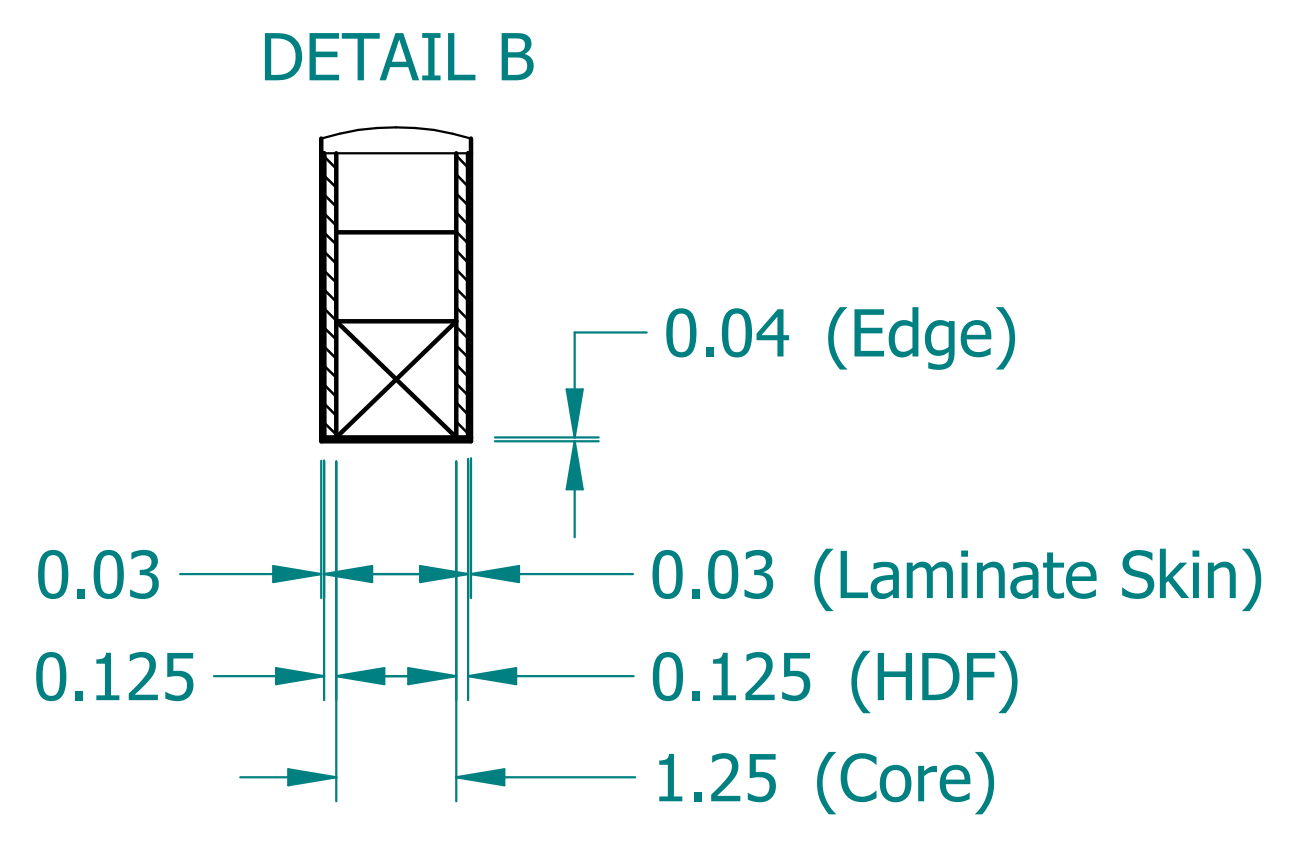

	NAME	DATE
DRAWN	CBS	12/18/23
ENG APPR	CBS	12/18/23

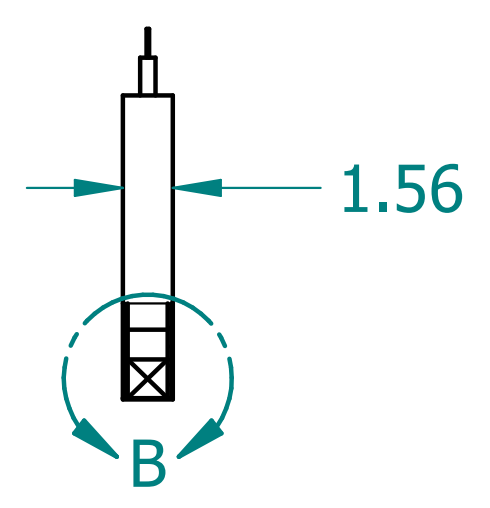
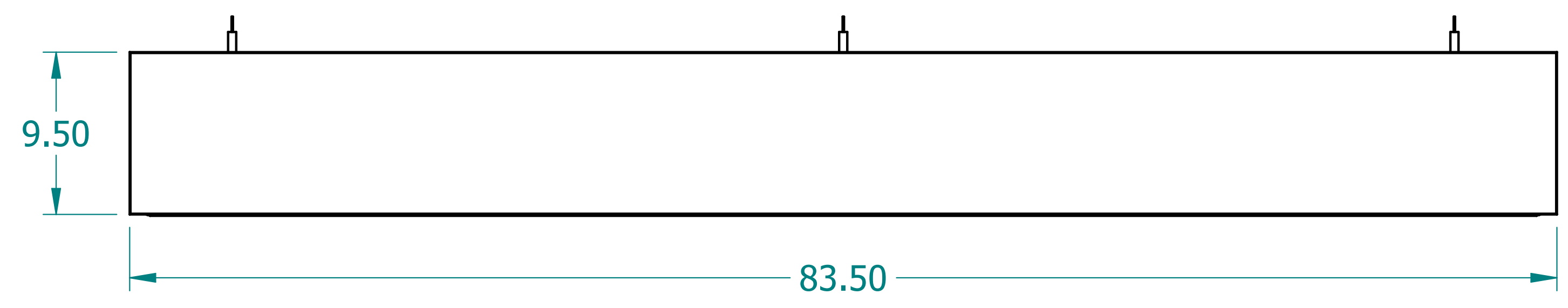
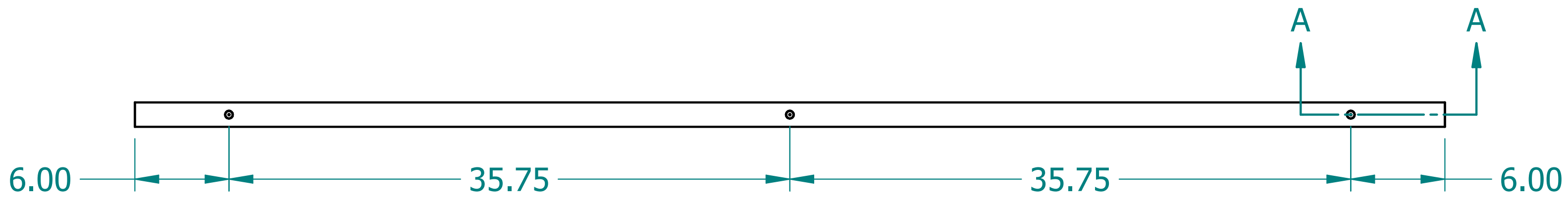
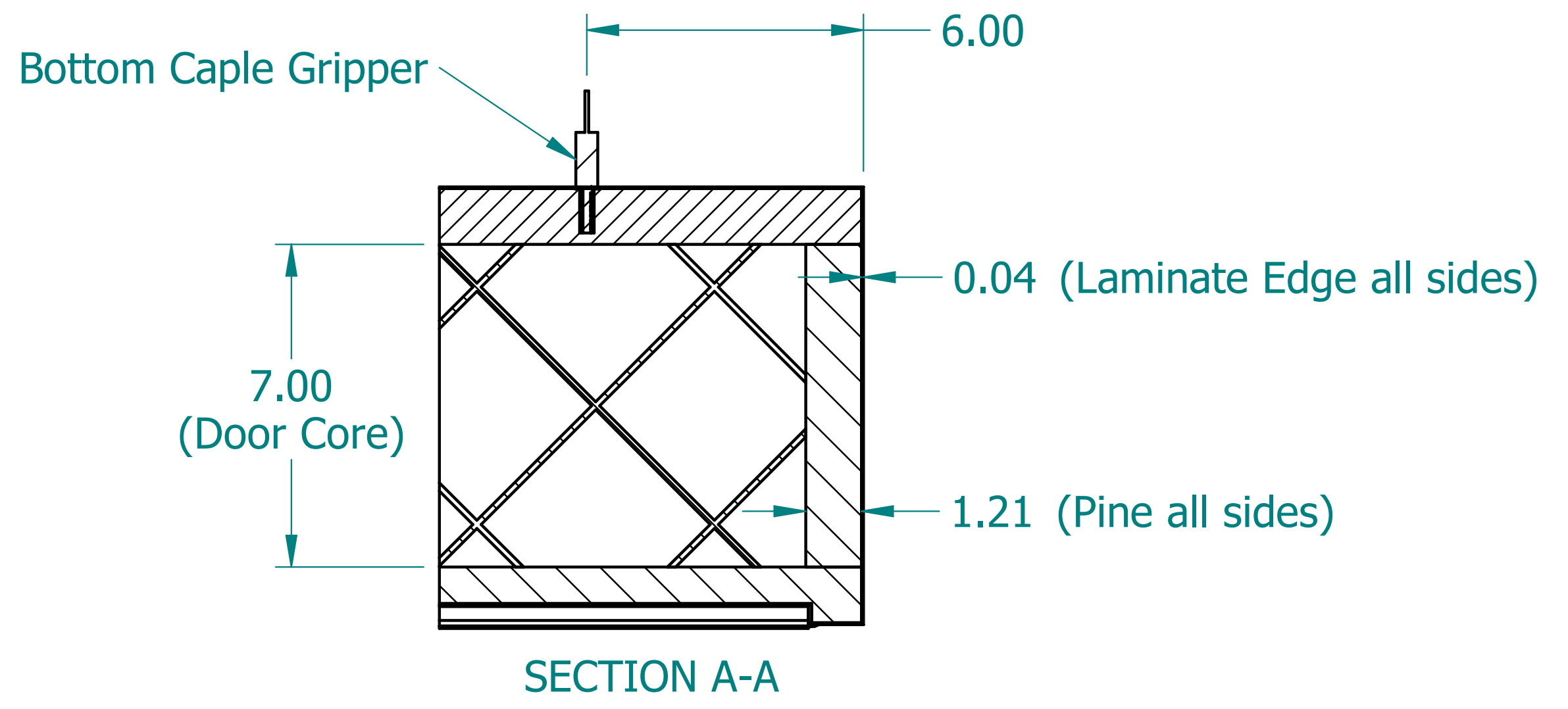
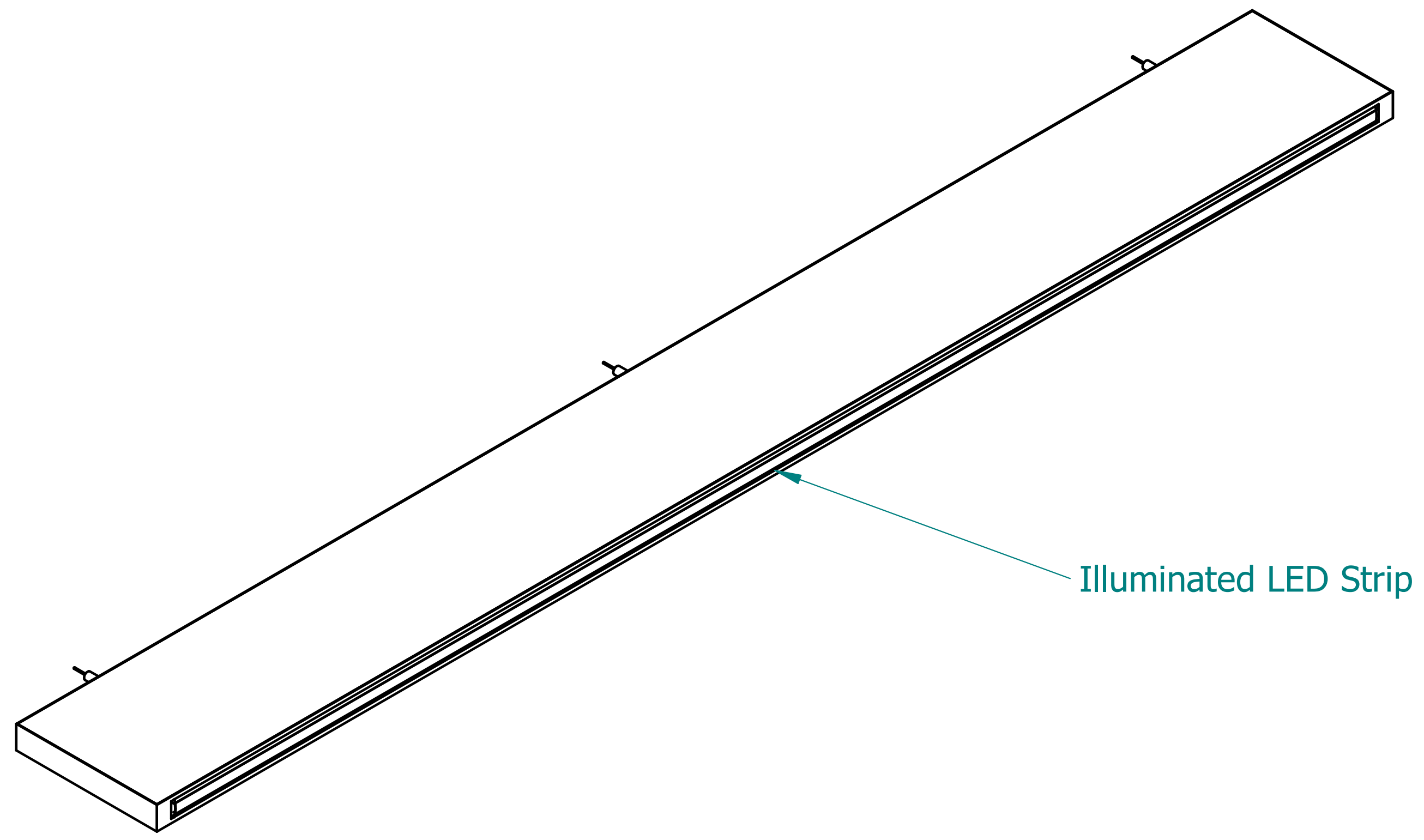

UNLESS OTHERWISE SPECIFIED DIMENSIONS ARE IN 'INCHES'
 ANGLES $\pm 0.8^\circ$; 2 PL ± 0.040 ; 3 PL ± 0.020

TITLE Illuminated Laminate Beam	
SUBTITLE 84"x10"x1.5"	
PART NO: IXBeam-063-XX	REV. 1.0
SIZE: 34"x22"	SCALE: 0.17
SHEET 1 OF 1	
FILE NAME: Illuminated Laminated Beam (84.10.1.5).dft	