

REVISION HISTORY			
REV.	DESCRIPTION	DATE	APPROVED

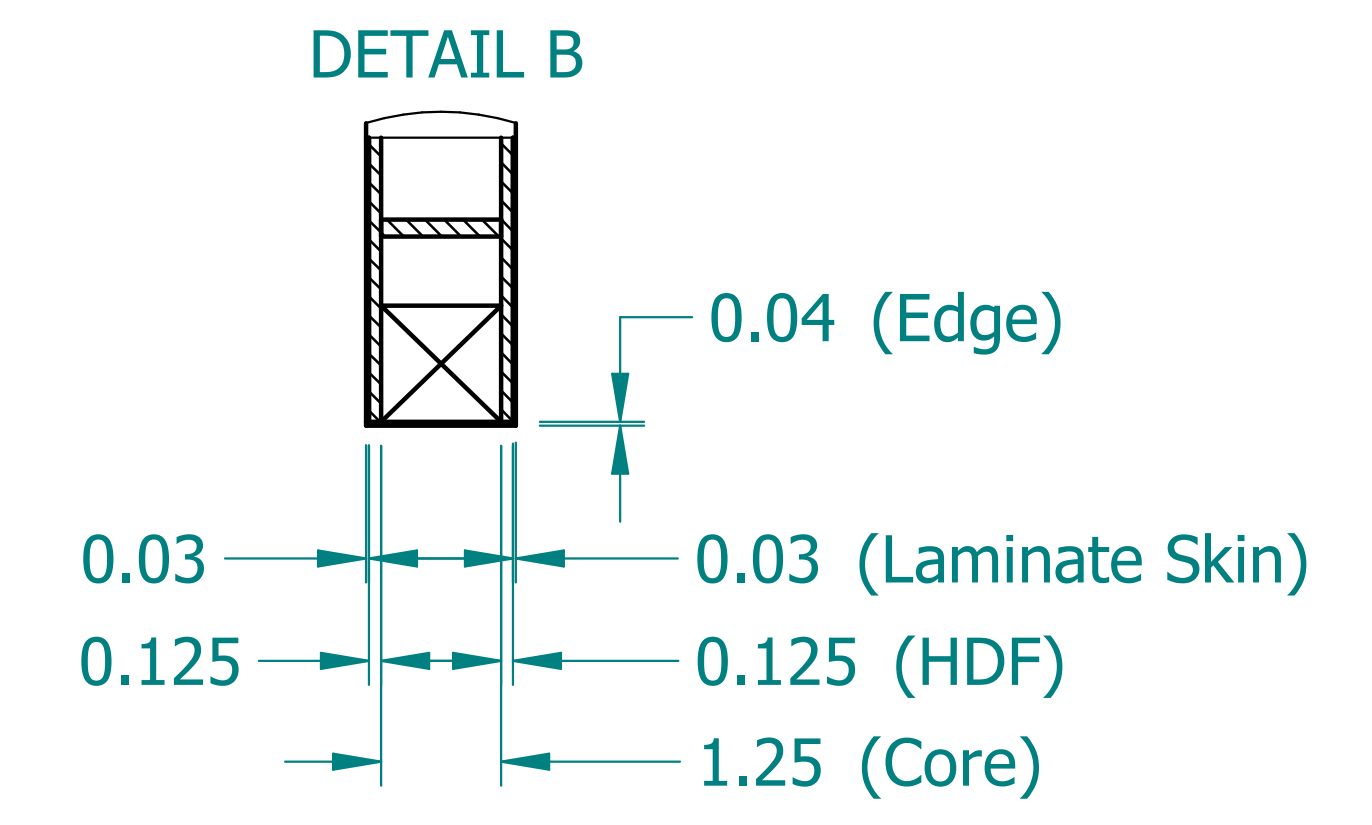
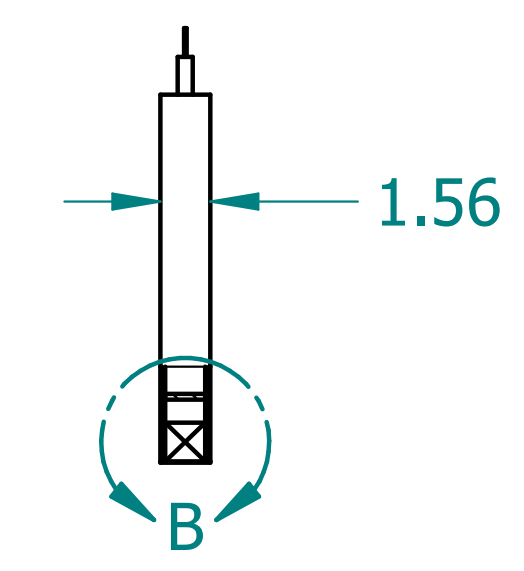
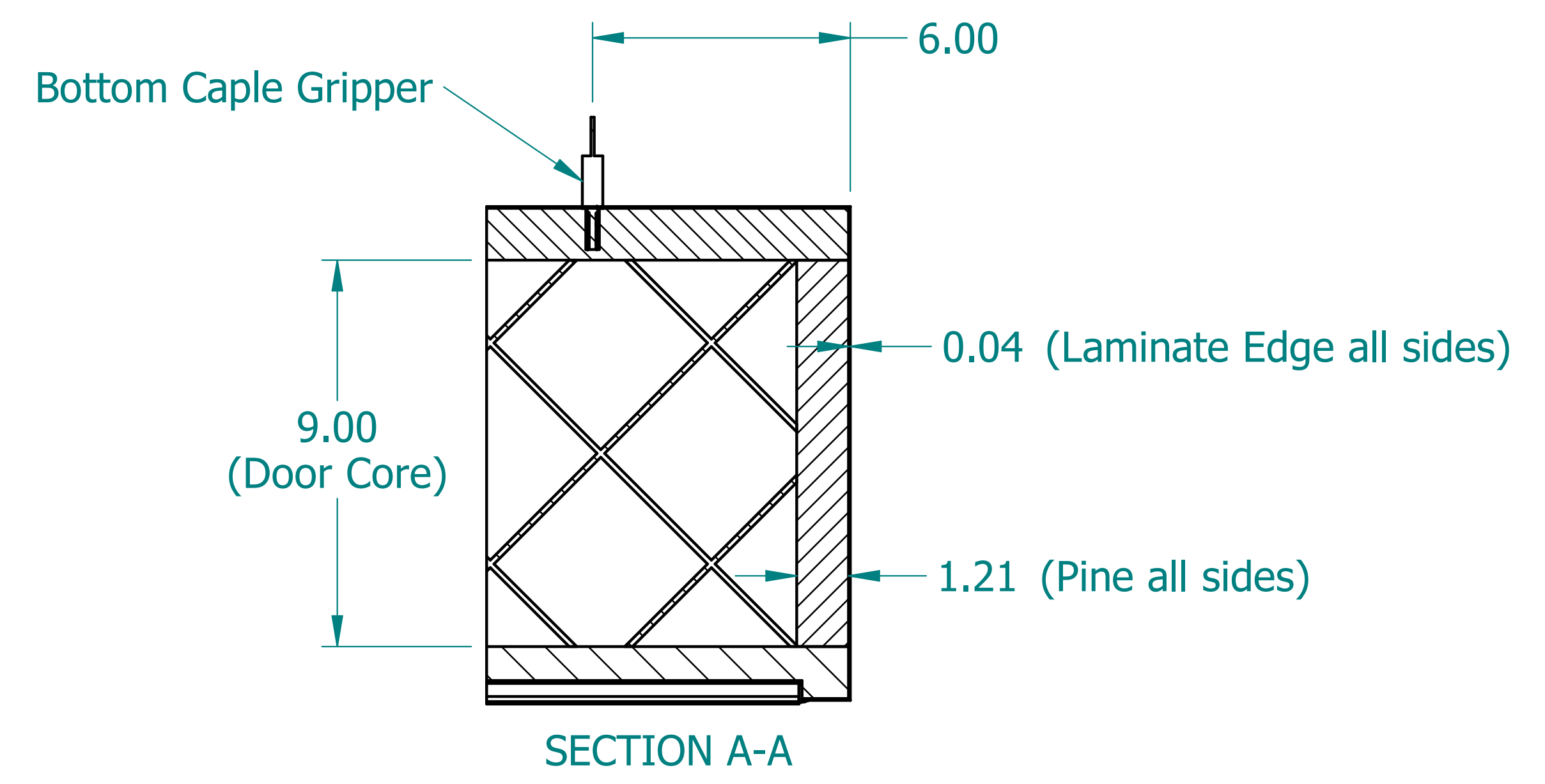
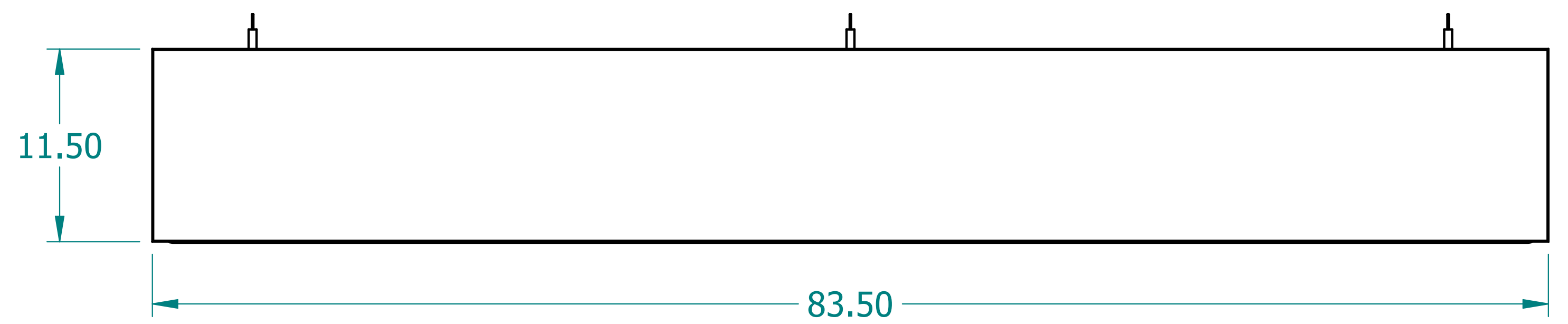
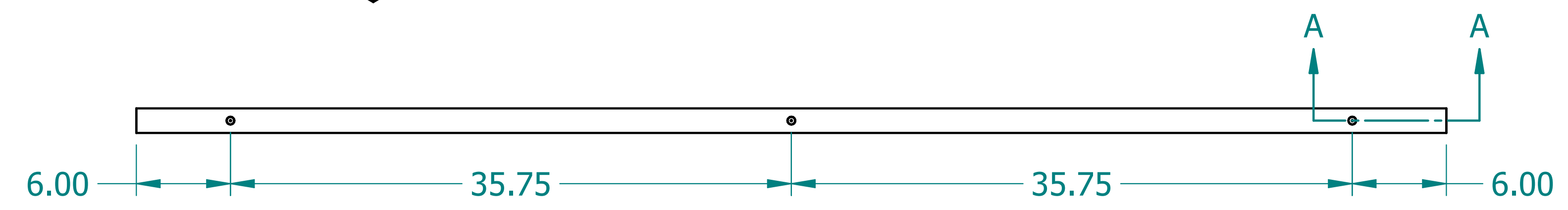
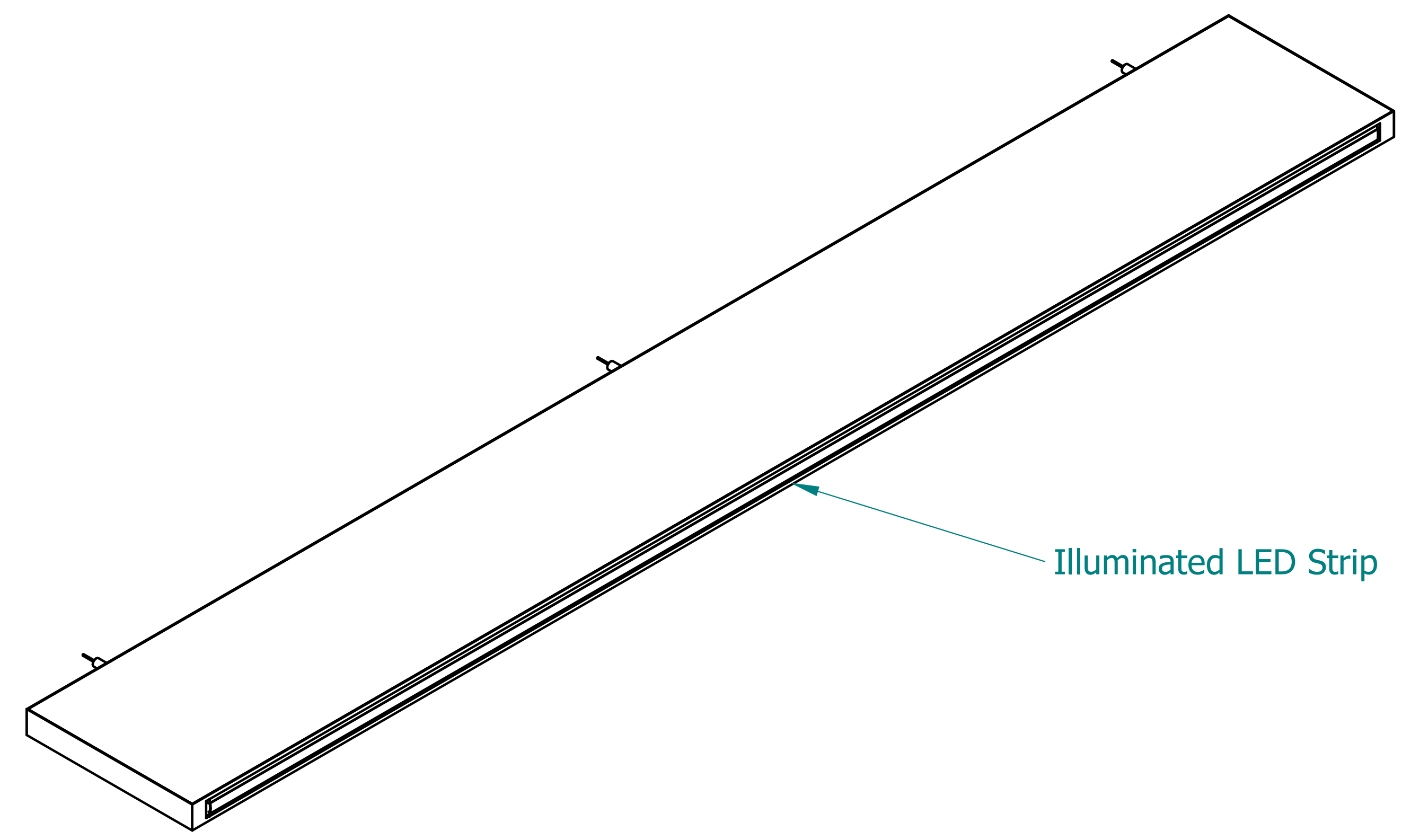

NAME	DATE	
DRAWN CBS	12/18/23	
ENG APPR CBS	12/18/23	
		TITLE
UNLESS OTHERWISE SPECIFIED DIMENSIONS ARE IN 'INCHES' ANGLES $\pm 0.8^\circ$ ; 2 PL $\pm 0.040$ ; 3 PL $\pm 0.020$		<b>Illuminated Laminate Beam</b>
		SUBTITLE
		84"x12"x1.5"
		PART NO: IXBeam-064-XX
		REV. 1.0
		SIZE: 34"x22" SCALE: 0.17 SHEET 1 OF 1
		FILE NAME: Illuminated Laminated Beam (84.12.1.5).dft