

REVISION HISTORY			
REV.	DESCRIPTION	DATE	APPROVED

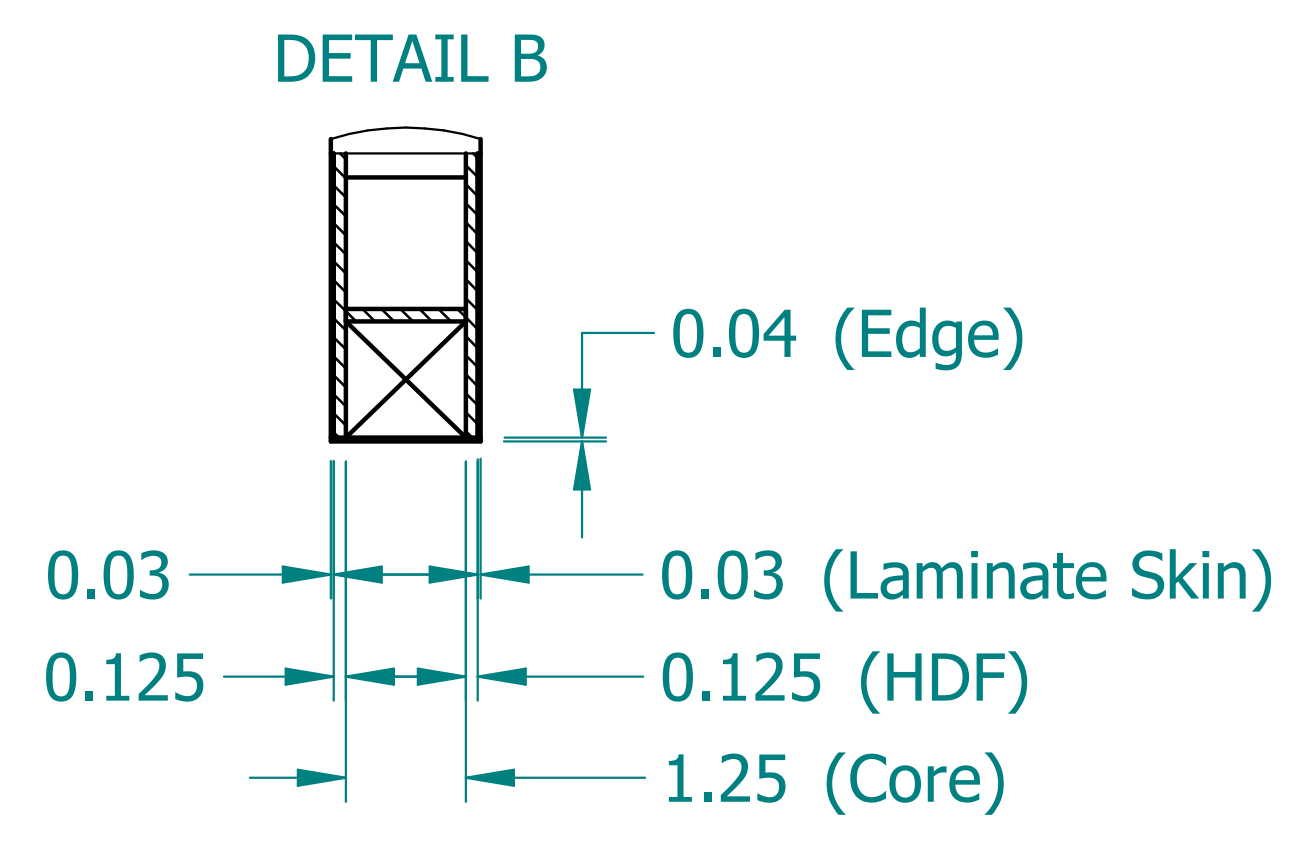

	NAME	DATE
DRAWN	CBS	12/18/23
ENG APPR	CBS	12/18/23

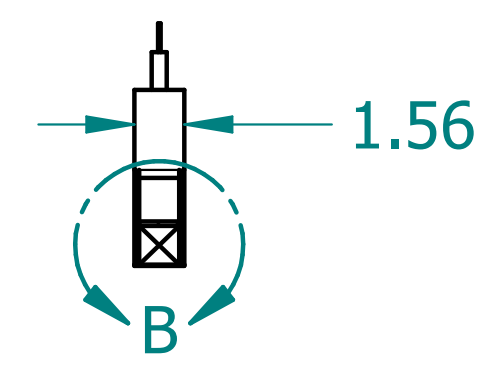
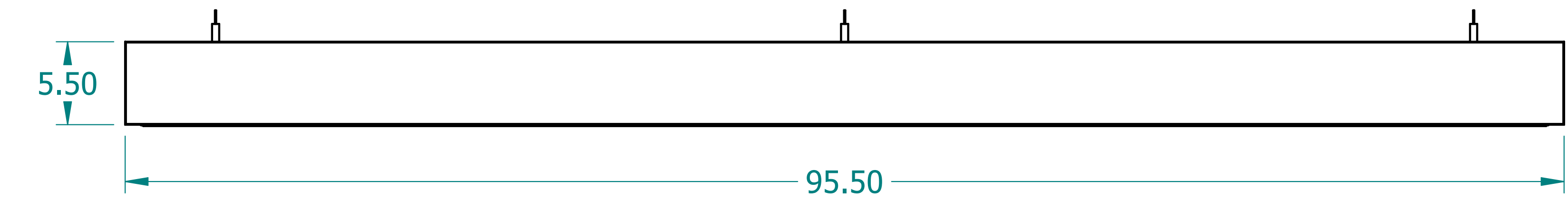
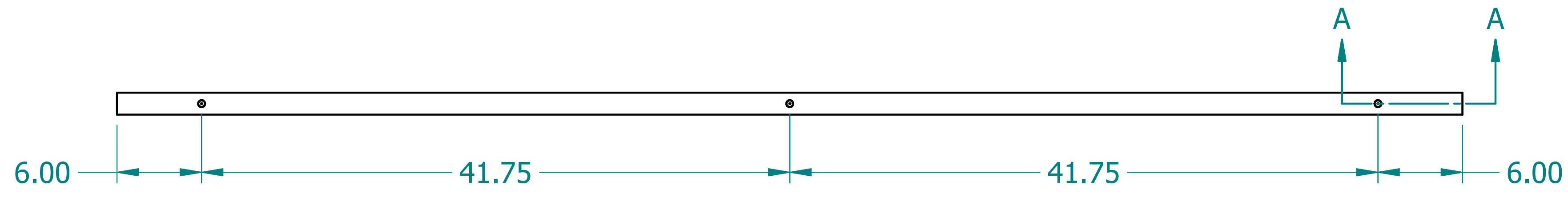
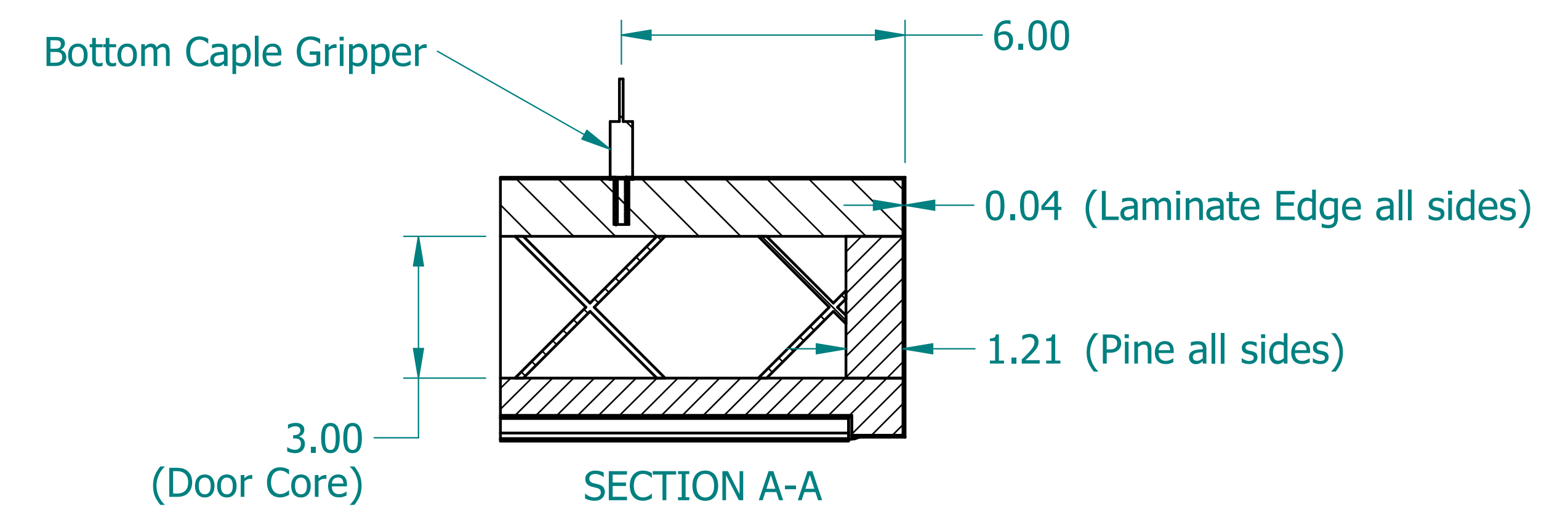
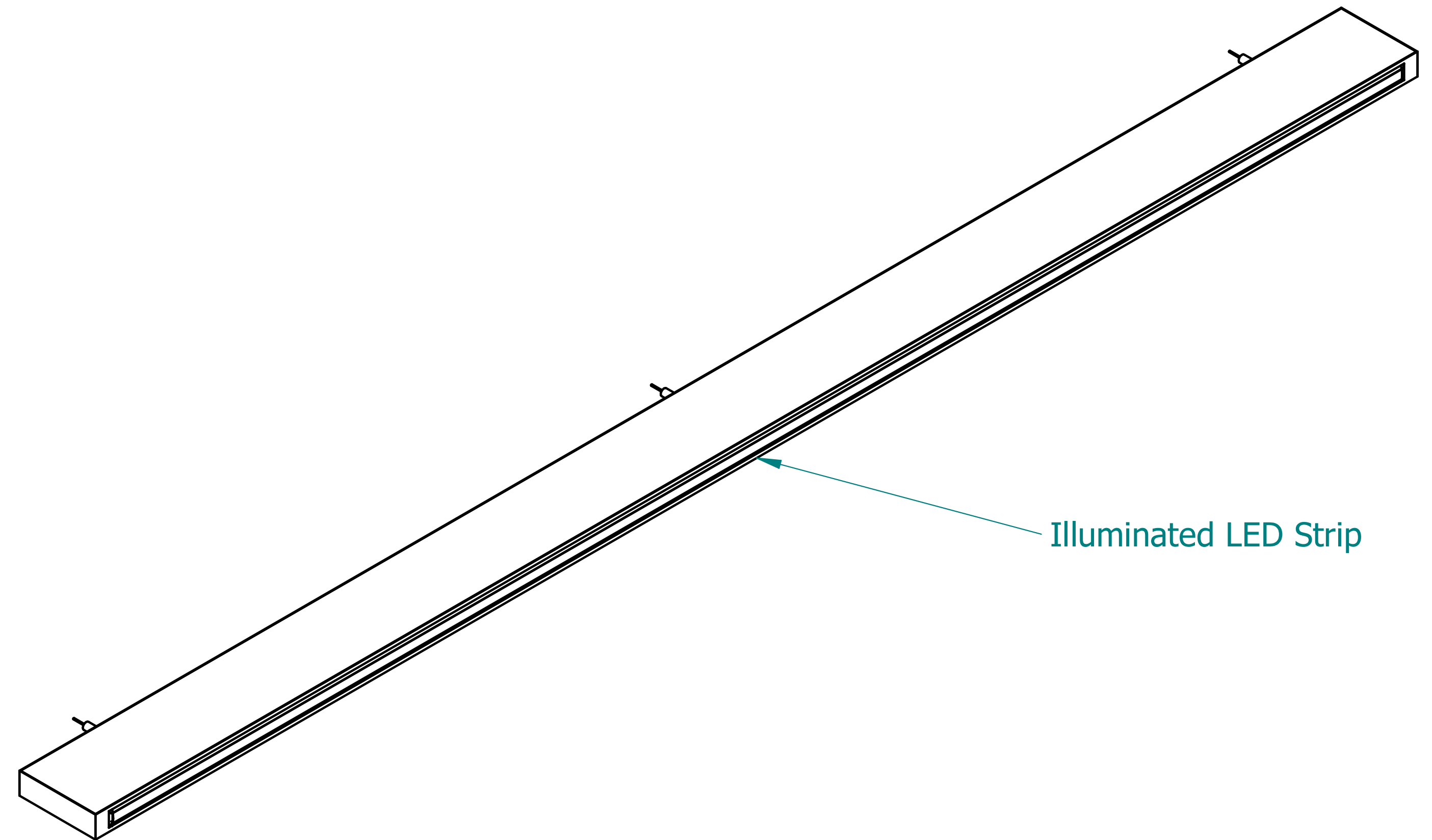

UNLESS OTHERWISE SPECIFIED DIMENSIONS ARE IN 'INCHES'
 ANGLES $\pm 0.8^\circ$; 2 PL ± 0.040 ;
 3 PL ± 0.020

TITLE Illuminated Laminate Beam		
SUBTITLE 96"x6"x1.5"		
PART NO: IXBeam-073-XX	REV. 1.0	
SIZE: 34"x22"	SCALE: 0.17	SHEET 1 OF 1
FILE NAME: Illuminated Laminated Beam (96.6.1.5).dft		